

DATA TRANSLATION

UM-26088-E

DT7816
User's Manual

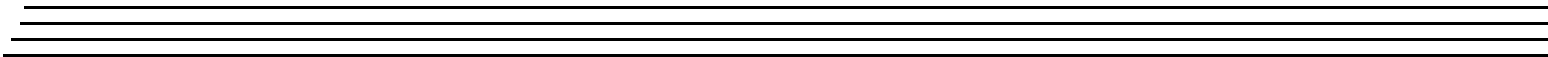
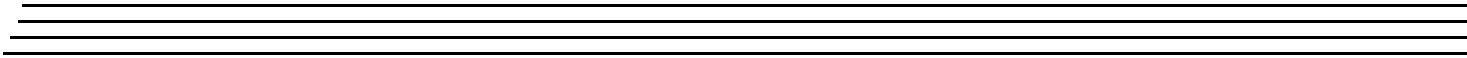
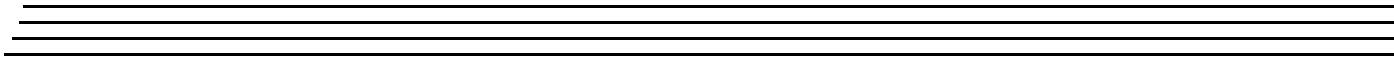

**Fifth Edition
December, 2015**

Copyright © 2015 by Data Translation, Inc.
All rights reserved.

Information furnished by Data Translation, Inc. is believed to be accurate and reliable; however, no responsibility is assumed by Data Translation, Inc. for its use; nor for any infringements of patents or other rights of third parties which may result from its use. No license is granted by implication or otherwise under any patent rights of Data Translation, Inc.

Use, duplication, or disclosure by the United States Government is subject to restrictions as set forth in subparagraph (c)(1)(ii) of the Rights in Technical Data and Computer software clause at 48 C.F.R, 252.227-7013, or in subparagraph (c)(2) of the Commercial Computer Software - Registered Rights clause at 48 C.F.R., 52-227-19 as applicable. Data Translation, Inc., 100 Locke Drive, Marlboro, MA 01752.

The DT7816 software is based of the Linux open-source development environment which uses the GNU (General Public License). Data Translation example programs may use code from other vendors. This code is for demonstration purposes only. If you want to use this code for commercial purposes, you must ensure that you resolve any licensing issues with the appropriate parties.

Data Translation, Inc.
100 Locke Drive
Marlboro, MA 01752-1192
(508) 481-3700
www.datatranslation.com
Fax: (508) 481-8620
E-mail: info@datx.com

Data Translation® is a registered trademark of Data Translation, Inc.

All other brand and product names are trademarks or registered trademarks of their respective companies.

Radio and Television Interference

This equipment has been tested and found to comply with CISPR EN55022 Class A and EN61000-6-1 requirements and also with the limits for a Class A digital device, pursuant to Part 15 of the FCC Rules. These limits are designed to provide reasonable protection against harmful interference when the equipment is operated in a commercial environment. This equipment generates, uses, and can radiate radio frequency energy and, if not installed and used in accordance with the instruction manual, may cause harmful interference to radio communications. Operation of this equipment in a residential area is likely to cause harmful interference, in which case the user will be required to correct the interference at his own expense.

Changes or modifications to this equipment not expressly approved by Data Translation could void your authority to operate the equipment under Part 15 of the FCC Rules.

Note: This product was verified to meet FCC requirements under test conditions that included use of shielded cables and connectors between system components. It is important that you use shielded cables and connectors to reduce the possibility of causing interference to radio, television, and other electronic devices.

Canadian Department of Communications Statement

This digital apparatus does not exceed the Class A limits for radio noise emissions from digital apparatus set out in the Radio Interference Regulations of the Canadian Department of Communications.

Le présent appareil numérique n'émet pas de bruits radioélectriques dépassant les limites applicables aux appareils numériques de la class A prescrites dans le Règlement sur le brouillage radioélectrique édicté par le Ministère des Communications du Canada.

Table of Contents

About this Manual	9
Intended Audience	9
How this Manual is Organized	9
Conventions Used in this Manual	9
Related Information	10
Where To Get Help	10
Chapter 1: Overview	11
Hardware Features	12
Board Layout Overview	15
Supported Software	16
Supported Accessories	18
Getting Started Procedure	20
Chapter 2: Principles of Operation	21
Block Diagram	22
ARM Block	23
ARM Processor	23
Memory	23
Embedded NAND Flash	23
EEPROM	23
Micro SD Card	23
USB Device (Client) Port	24
USB Host Port	24
Serial Port 0	24
Serial Port 1 / I2C2 Port	24
SPI Port	24
GPMC Bus Interface	24
Analog Input Features	25
Analog Input Channels	25
Input Ranges	25
Input Resolution	25
Continuous Sampling Mode	26
Input Triggers	27
Input Clock Source and Sampling Frequency	28
Input FIFO and Data Format	28
Error Conditions	29
Analog Output Features	30
Analog Output Channels	30

Output Range and Gain	30
Output Resolution	30
Output Clocks	30
Output Conversion Modes	31
Single-Value Mode	31
Continuous Analog Output Operations	31
Output Trigger	32
Output FIFO and Data Format	32
Error Conditions	32
Tachometer Input Features	33
General-Purpose Counter/Timer Features	35
C/T Channels	35
C/T Clock Input Sources	36
Gate Types	36
Pulse Output Period, Pulse Width, and Polarity	37
Counter/Timer Operation Modes	38
Event Counting	38
Rate Generation	39
Non-Retriggerable One-Shot	40
Idle Mode	41
Measure Counter Features	42
Digital I/O Features	46
Digital I/O Lines	46
Operation Modes	46
Synchronizing Acquisition on Multiple Modules	48
Chapter 3: Troubleshooting	49
Technical Support	50
If Your Module Needs Factory Service	51
Chapter 4: Calibration	53
Overview	54
Calibrating the Analog Input Subsystem	55
Calibrating the Analog Output Subsystem	56
Appendix A: Specifications	59
Analog Input Specifications	60
Analog Output Specifications	62
Digital Input Specifications	63
Digital Output Specifications	64
Tachometer Input Specifications	65
Measure Counter Specifications	66

General-Purpose Counter/Timer Specifications	67
Trigger Specifications	68
Master Oscillator Specifications	69
Power, Physical, and Environmental Specifications	70
Regulatory Specifications	71
Connector Specifications	72
External Power Supply Specifications	73
Appendix B: Connector Pin Assignments and LEDs	75
Digital I/O Header (J15)	76
Analog I/O Header (J16)	79
Digital Function Header (J14)	80
USB Device (Client) Connector	81
USB Host Connector	82
Ethernet Connector	83
External +5 V Power Connector	84
Serial Connectors	86
Serial Port 0 (UART 0)	86
SPI Connector	87
Serial Port 1 / I ² C2 Connector	88
STP781x Screw Terminal Panel	89
LED Status Indicators	92
User LEDs	94
Index	97

About this Manual

The first part of this manual describes how to install and set up your DT7816 module and verify that your module is working properly.

The second part of this manual describes the features of the DT7816 module and how to program the DT7816 module using Linux system calls. Troubleshooting information is also provided.

Intended Audience

This document is intended for engineers, scientists, technicians, or others responsible for using and/or programming a DT7816 module for data acquisition operations in the Linux operating system. It is assumed that you have some familiarity with data acquisition principles and that you understand your application.

How this Manual is Organized

This manual is organized as follows:

- [Chapter 1, “Overview,”](#) describes the major features of the DT7816 module, as well as the supported software and accessories for the module.
- [Chapter 2, “Principles of Operation,”](#) describes all of the features of the DT7816 module.
- [Chapter 3, “Troubleshooting,”](#) provides information that you can use to resolve problems with the DT7816 module should they occur.
- [Chapter 4, “Calibration,”](#) describes how to calibrate the analog circuitry of the DT7816 module.
- [Appendix A, “Specifications,”](#) lists the specifications of the DT7816 module.
- [Appendix B, “Connector Pin Assignments and LEDs,”](#) lists the pin assignments of the connectors on the DT7816 module, and describes the LED status indicators on the DT7816 module.
- An index completes this manual.

Conventions Used in this Manual

The following conventions are used in this manual:

- Notes provide useful information or information that requires special emphasis, cautions provide information to help you avoid losing data or damaging your equipment, and warnings provide information to help you avoid catastrophic damage to yourself or your equipment.
- Items that you select or type are shown in **bold**.

Related Information

Refer to the following documents, which can be found on the DT7816 web page on our website (<http://www.datatranslation.us/Products/ARM-Data-Acquisition/DT7816>) for more information on using the DT7816 module:

- *DT7816 Getting Started* help file
- *DT7816 File I/O Programming Manual*

Refer to your Linux documentation for more information about Linux and Texas Instruments documentation for more information on the TI Sitara AM3352, 1 GHz, ARM® Cortex-A8 processor.

Where To Get Help

Should you run into problems installing or using a DT7816 module, the Data Translation Technical Support Department is available to provide technical assistance. Refer to [Chapter 4](#) for more information. If you are outside the United States or Canada, call your local distributor, whose number is listed on our web site (www.datatranslation.com).



Overview

Hardware Features.....	12
Board Layout Overview	15
Supported Software	16
Supported Accessories.....	18
Getting Started Procedure.....	20

Hardware Features

The DT7816 SOM (System on Module), shown in [Figure 1](#), is an open-source Linux computing platform with analog and digital I/O circuitry, making it ideal for embedded applications that require high-performance, simultaneous data acquisition and control.



Figure 1: DT7816 SOM

The key features of the DT7816 are as follows:

- Open-source computing platform featuring a TI Sitara AM3352, 1 GHz, ARM® Cortex-A8 processor.
- Linux distribution consisting of a Linux kernel, bootloader, and file system with a DT7816 device driver, USB device (client) driver, and USB host driver.
- Ethernet 10/100 Mbps connectivity to a host computer.
- USB 2.0 high-speed connectivity to a host computer.
- USB 2.0 host connection to external devices, such as an external memory stick or hub.
- Analog input subsystem:
 - Eight, 16-bit, simultaneously sampled analog input channels.
 - Input range of ± 10 V.
 - Software-programmable internal or external A/D sample clock.
 - Programmable throughput rate up to 400 kSamples/s.
 - Continuous acquisition from multiple analog input channels simultaneously.

- Supports the ability to return the value of the tachometer, measure counter, and/or digital input lines in the input data stream, allowing you to measure a variety of signals synchronously with analog input measurements.
- Software-programmable trigger source (software trigger, external trigger, or threshold trigger using any analog input channel) to start acquisition.
- Analog input signals are brought out on the 20-pin Analog I/O header.
- Analog output subsystem:
 - Two, 16-bit, simultaneously updated analog output channels.
 - Single value and continuous streaming output.
 - Output range of ± 10 V.
 - Software-programmable internal or external D/A clock.
 - Programmable output rate up to 400 kSamples.
 - Supports the ability to update the digital output lines synchronously with the analog output channels.
 - Software-programmable trigger source (software trigger or external digital trigger) to start the analog output operation.
 - Analog output signals are brought out on the 20-pin Analog I/O header.
- Up to eight, TTL digital input lines using eight general-purpose input signals. You can read the digital input port directly or you can return the value of the digital input port in the input data stream. Digital input signals are brought out on the 34-pin Digital I/O header.
- Up to eight, LVTTTL digital output lines using eight general-purpose output signals. You can write a value to the digital output port directly or you can update the digital output lines through the output data stream. The digital outputs are LVTTTL signals with 4 mA sink and 10 mA source capabilities. Digital output signals are brought out on the 34-pin Digital I/O header.
- One, 32-bit, general-purpose counter/timer for performing event counting, rate generation, and non-retriggerable one-shot operations. You can use two general-purpose input signals for the C/T clock and gate inputs and one general-purpose output signal for the C/T clock output. You can read the value of the counter/timer directly through a synchronous read operation.
- One tachometer input signal. The value of the tachometer input signal can be returned in the input stream. The tachometer input signal is brought out on the 20-pin Digital Function header.
- One phase/measure counter. You can program the edge that starts the measurement and the edge that stops the measurement. Many edge types are supported. The data from the measure counter can be returned in the input stream.
- 2 GB embedded NAND flash memory that contains the Linux kernel, bootloader, and file system; this memory can also be used to store user files and data.
- 512 MB SDRAM (DDR3) memory.
- 8 kBytes EEPROM.

- Micro SD connector supports micro SD cards, which can be used as a boot source or for general-purpose file and data storage.
- 3.3 V UART, I²C2, and an SPI (Serial Peripheral Interface) interfaces for embedded connectivity.
- Serial debug port.
- External power connector for connecting a +5 VDC power supply.

Board Layout Overview

Figure 2 shows the layout of the DT7816 module.

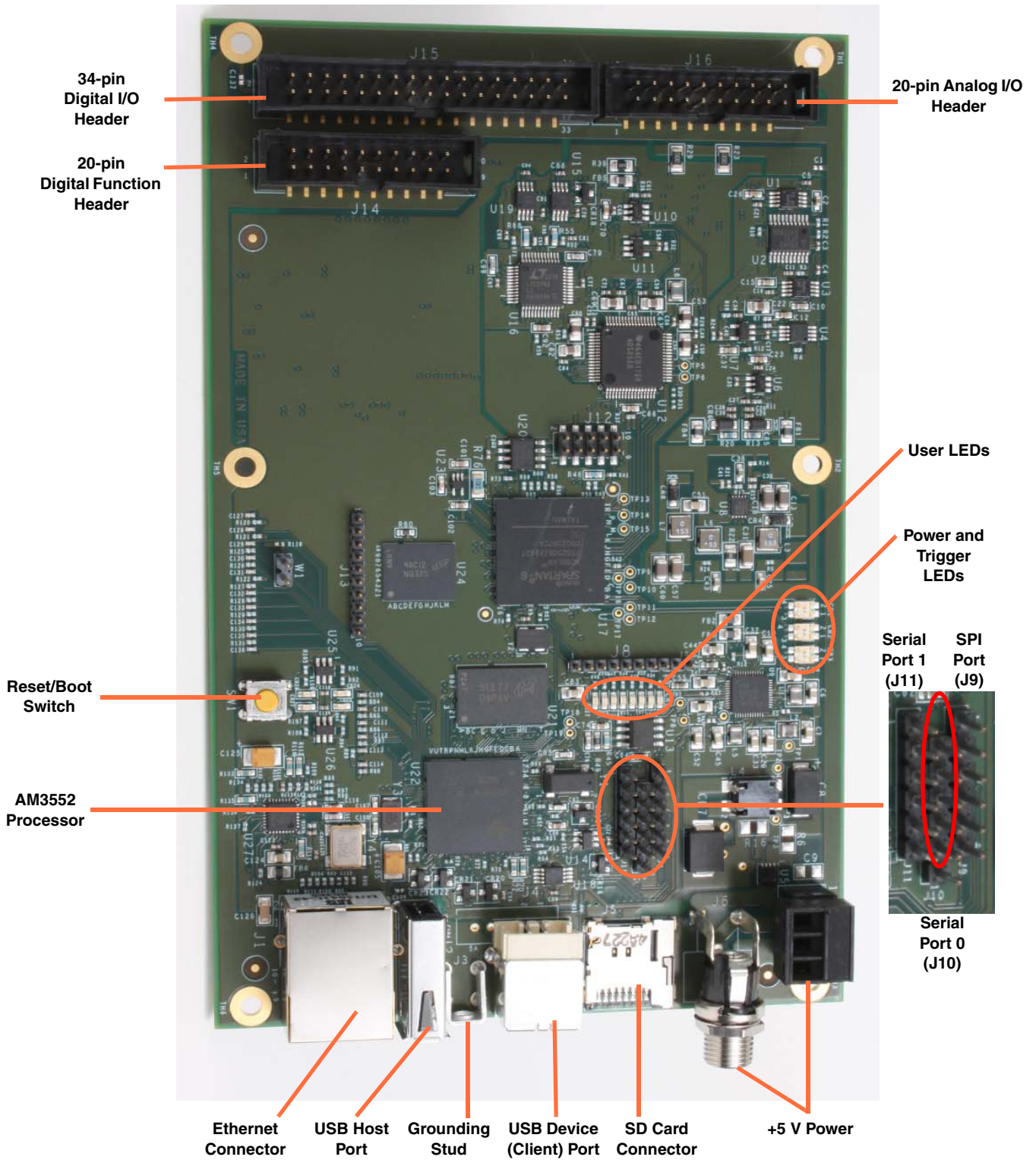

Figure 2: Layout of the DT7816 Module

Supported Software

The DT7816 module runs Linux 3.12 (Debian distribution) with custom loadable kernel modules (LKM) or device drivers.

The DT7816 device drivers and numerous example application programs reside on the DT7816 module. The drivers are loaded when the DT7816 module is powered up. The example programs demonstrate the functionality of the hardware and how to use file I/O commands to write application programs for the module. A calibration example is also provided for calibrating the analog circuitry of the DT7816 module. Refer to [Chapter 4](#) for more information on using the calibration example.

The device drivers (DT78xx driver and DT78xx USB driver), shown in [Figure 3](#), expose the functionality of the module to Linux user space applications using virtual file interfaces.

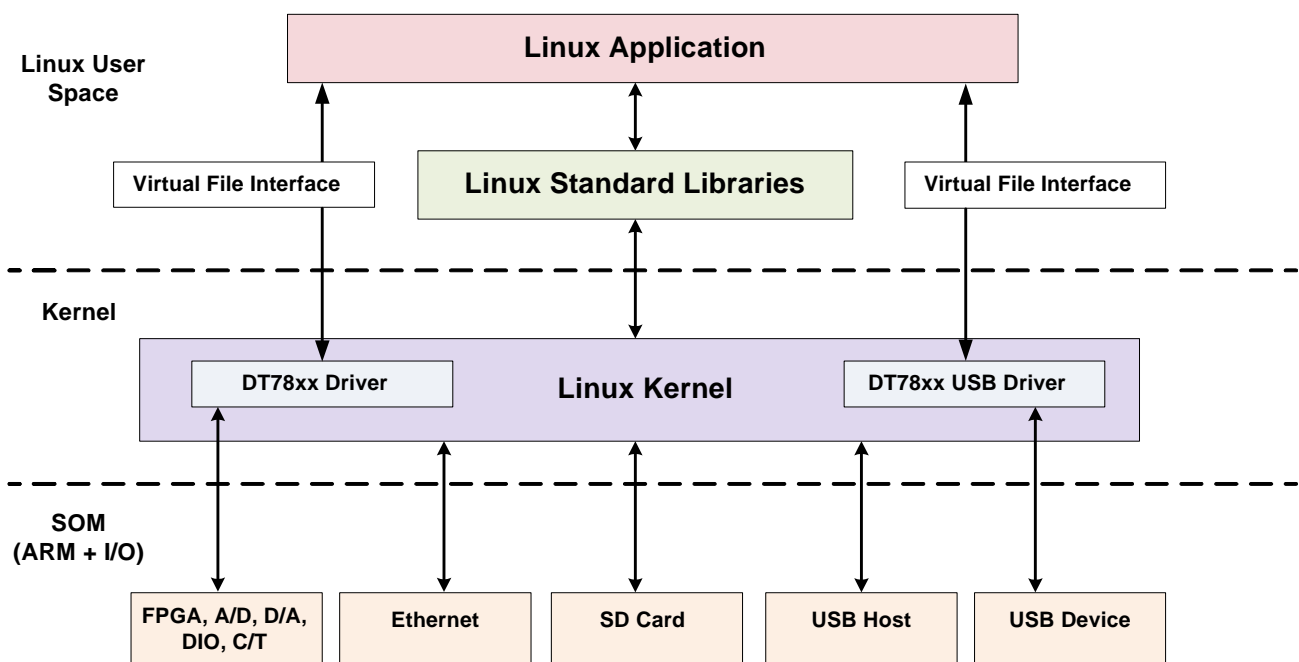

Figure 3: Software Architecture of the DT7816

For example, the DT7816 module uses the following files to access its subsystems:

- /dev/DT7816-ain – Analog input subsystem.
- /dev/DT7816-aout – Analog output subsystem.
- /dev/DT7816-din – Digital input subsystem.
- /dev/DT7816-dout – Digital output subsystem.
- /dev/DT7816-tach – Tachometer input subsystem.
- /dev/DT7816-measure – Measure counter subsystem.

- /dev/DT7816-ctr-tmr – Counter/timer subsystem.
- /dev/DT7816-stream-in – Input stream.
- /dev/DT7816-stream-out – Output stream.

The USB device functionality of the DT7816 is accessible to user-space embedded applications using the following files:

- /dev/DT7816-ep1in
- /dev/DT7816-ep1out
- /dev/DT7816-ep2in
- /dev/DT7816-ep2out
- /dev/DT7816-ep3out
- /dev/DT7816-ep4out
- /dev/DT7816-ep5out

User applications can perform standard file operations such as open, close, read, write, on the files to access and control the hardware. For instance, to access the digital input subsystem on the DT7816 module, the application uses the virtual file handle for the digital input subsystem (/dev/DT7816-din) as follows:

- Opens the file /dev/DT7816-din, thereby allowing access to the digital input subsystem.
- If supported, configures parameters for the digital input subsystem using IOCTL commands.
- Reads from the file, which in turn, reads the value of the digital input port and returns a value.
- Closes the file.

Refer to the *DT7816 File I/O Programming Manual* for more information about writing application programs for the DT7816 module using virtual file interfaces and file I/O commands.

Supported Accessories

The following optional accessories are available for a DT7816 module:

- **STP781x screw terminal panel** – This screw terminal panel provides three connectors that mate to the three headers on the DT7816 module, allowing you to access all the signals on the DT7816 module.

[Figure 4](#) shows the STP781x screw terminal panel mounted on the DT7816.

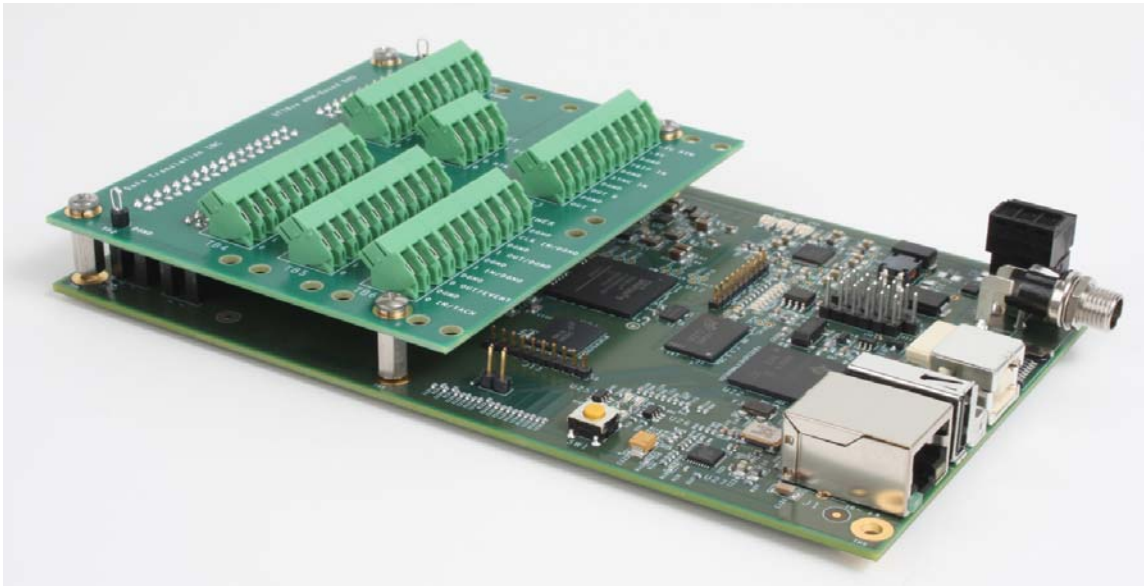

Figure 4: STP781x Screw Terminal Panel Mounted on the DT7816

- **EP405 USB to Serial TTL Debug Cable** – This 3Mbaud, 1.8 m cable, shown in [Figure 5](#), connects the USB port of the host computer to serial UART connector J9 on the DT7816, allowing you to debug the DT7816 using a terminal interface.



Figure 5: EP405 USB to Serial TTL Debug Cable

- **EP394 External Power Supply** – This +5 VDC optional power supply and cable, shown in [Figure 6](#), connects to the barrel power connector on the DT7816 module and to the wall power outlet.



Figure 6: EP394 +5 VDC External Power Supply

Getting Started Procedure

Refer to the *DT7816 Getting Started* help file on our web site (<http://www.datatranslation.us/Products/ARM-Data-Acquisition/DT7816>) for getting started information.



Principles of Operation

Block Diagram	22
ARM Block.....	23
Analog Input Features	25
Analog Output Features	30
Tachometer Input Features	33
General-Purpose Counter/Timer Features.....	35
Measure Counter Features	42
Digital I/O Features.....	46
Synchronizing Acquisition on Multiple Modules	48

Block Diagram

The DT7816 is an open-source Linux computing platform with analog and digital I/O circuitry. Figure 7 shows a block diagram of the DT7816 module.

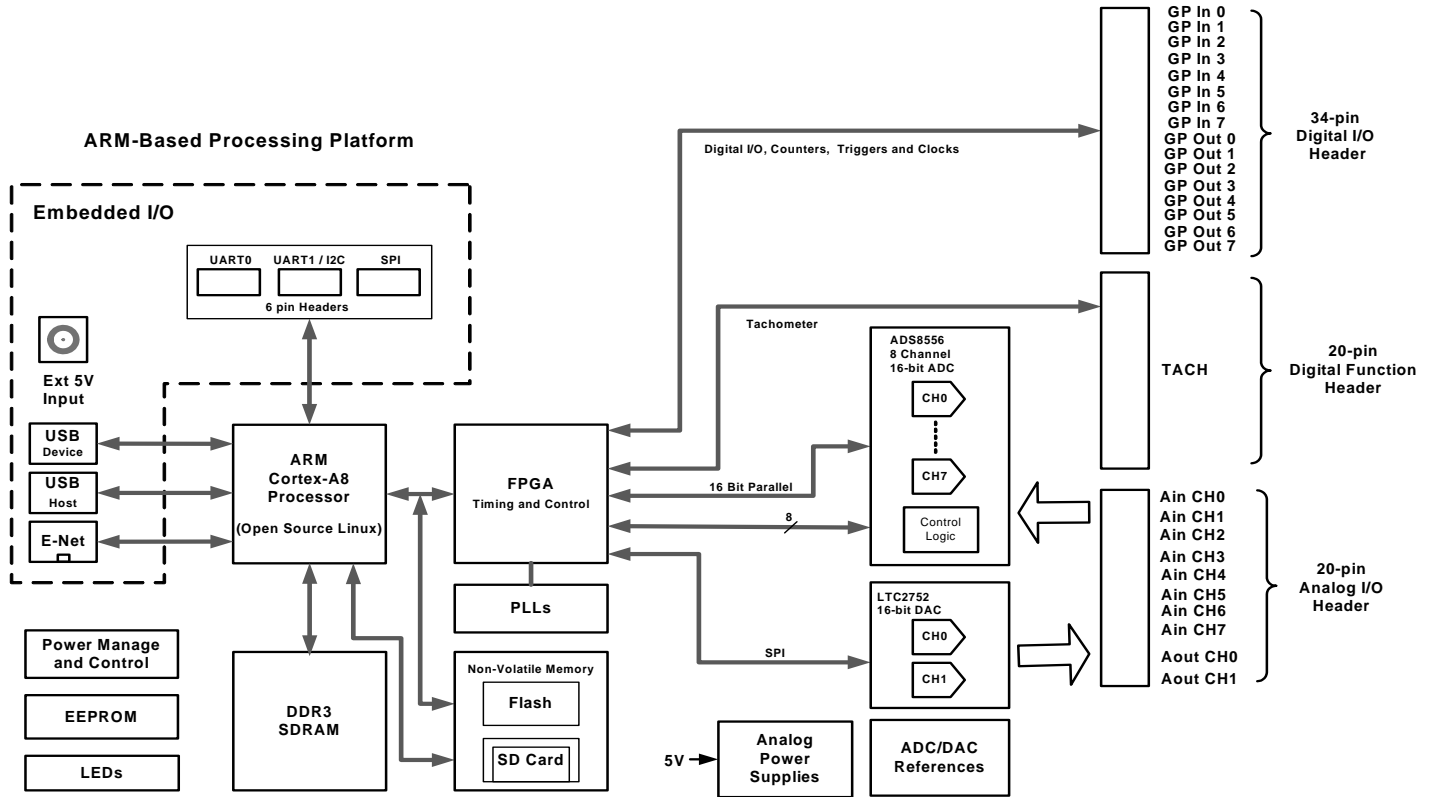

Figure 7: Block Diagram of the DT7816 Module

ARM Block

The ARM block of the DT7816 module uses the TI Sitara AM3352 processor and its associated peripherals to provide an open-source, single-board computer. The AM3352 supports many different interfaces, many of which are shared on the configurable I/O pins. In addition to the AM3352, the DT7816 module uses an embedded NAND flash and an FPGA.

This section describes the features of the ARM block in more detail.

ARM Processor

The AM3352 is based on the ARM Cortex-8 32-bit processor and is configured to run at 1 GHz.

Refer to the following web site for more information on this processor:

<http://www.ti.com/product/am3352>

Memory

A 512 MB, DDR3, SDRAM memory device is connected to the AM3352 processor through a dedicated DDR (Double Data Rate) memory interface.

Embedded NAND Flash

A 2 GB embedded NAND flash device is connected to the AM3352 processor through the 16-bit GPMC (General Purpose Memory Controller) bus, and can be accessed at the CS0 address space. The flash memory contains the Linux kernel, bootloader, and the file system.

You can also use the flash memory for general-purpose data and file storage as well as for input data and waveform storage.

EEPROM

An 8 kByte EEPROM device is connected to the I2C0, 2-wire, serial interface of the AM3352 processor. The EEPROM stores information about the device, including the calibration information.

Micro SD Card

A micro SD card slot is provided to support optional high-speed (up to 24 MB/s) micro SD cards. Micro SD cards (not provided with the module) communicate with the AM3352 processor using the MMC0 port in the 4-bit interface mode.

You can use a micro SD card as a boot source or for general-purpose file and data storage.

USB Device (Client) Port

The DT7816 module provides a USB 2.0 device (client) port on a type B receptacle. The device port connects to the USB port 0 controller of the AM3352 processor.

When connected to a host computer through this USB port, the host computer can identify the DT7816 module and load the appropriate drivers through the enumeration process.

USB Host Port

The DT7816 provides a high-speed USB 2.0 host port on a type A receptacle. The host port connects to the USB port 1 controller of the AM3352 processor. The USB host port supports any USB device, provided that the required software is installed on the Linux operating system.

If desired, you can connect USB devices, such as a memory stick or hub to this port.

Serial Port 0

Serial port 0 is a 3.3 V TTL serial interface provided on a 6-pin header. This port supports transmit and receive signals (no handshaking), and connects to the UART 0 interface of the AM3352 processor.

This port is particularly useful when you are debugging your applications. To use this port, use the EP405 USB to serial TTL adapter cable.

Serial Port 1 / I²C2 Port

Serial port 1 and the I²C2 port are provided on the same 6-pin header.

Serial port 1 is a 3.3 V TTL serial interface that supports transmit and receive signals, and connects to the UART1 interface of the AM3352 processor.

The bidirectional I²C2 port connects to the I²C port 2 interface of the AM3352 processor and is provided for embedded connectivity. It is possible to reconfigure the pins of the I²C port 2 interface as the remaining UART 1 pins to provide the full functionality of serial port 1.

SPI Port

The SPI (Serial Peripheral Interface) is provided on an additional 6-pin header for embedded connectivity. This port connects to the SPI port 1 interface of the AM3352 processor.

GPMC Bus Interface

A 16-bit address/data multiplexed bus interface is supplied by the processor. In addition to the NAND flash, this bus also supports the FPGA. All control registers for the DT7816 are accessible in the CS1 address space. The CS3 address space provides access to the input FIFO.

Analog Input Features

This section describes the following features of analog input (A/D) subsystem on the DT7816 module:

- Analog input channels, described on this page
- Input ranges and gains, described on this page
- Input resolution, described on this page
- Continuous sampling mode, described on [page 26](#)
- Input triggers, described on [page 27](#)
- Input sample clock source and sampling frequency, described on [page 28](#)
- Data format and transfer, described on [page 28](#)
- Error conditions, described on [page 29](#)

Analog Input Channels

The DT7816 module provides eight analog input channels (channels 0 to 7). These are single-ended channels. You can access these signals through the 20-pin Analog I/O header. Refer to [page 76](#) for the pin descriptions of the Analog I/O header and to the *DT7816 Getting Started* help file for wiring information.

The DT7816 module uses an 8-channel SAR (successive approximation register) A/D converter that simultaneously samples all eight analog input channels in the input data stream.

Using software, you can specify which analog input channels to sample by specifying the channel mask for the input stream. Analog input channels 0 to 7 correspond to bits 0 to 7 in the channel mask.

You can also include the tachometer, measure counter, and digital input port in the input stream, if desired. Refer to [page 26](#) for more information.

Input Ranges

The DT7816 module provides an input range of ± 10 V. A fixed gain of 1 is used.

Input Resolution

The resolution of the analog input channels is fixed at 16 bits; you cannot specify the resolution in software.

Continuous Sampling Mode

The DT7816 module supports continuous sampling of the input stream. This is an asynchronous I/O operation that is non-blocking so that your application can perform other operations while acquisition is being performed.

In continuous sampling mode, you can acquire data from the following channels in the input data stream: analog input channels 0 to 7, the tachometer input, the measure counter, and the digital input port. In software, you specify the channel mask for the input stream to determine which channels to sample. The bits of the channel mask are as follows:

- Channels (bits) 0 to 7 – Analog input channels 0 to 7
- Channel (bit) 8 – Tachometer; refer to [page 33](#) for more information
- Channel (bit) 10 – Measure counter; refer to [page 42](#) for more information
- Channel (bit) 11 – Digital input port; refer to [page 46](#) for more information

The trigger that starts acquisition for the channels in the input stream can be any of the supported start trigger sources. Refer to [page 27](#) for more information about the start trigger sources. However, the input stream of the module must be armed (using software) before the module can detect the trigger condition.

If a software trigger is specified as the start trigger, acquisition starts immediately when the software start command is executed. Otherwise, acquisition begins when the specified trigger signal is detected. When it detects the specified start trigger, the module simultaneously acquires data from all of the channels specified in the input stream. Acquisition repeats continuously until you stop the operation. The conversion rate is determined by the sampling frequency; refer to [page 28](#) for more information.

When you stop the operation using software, the DMA engine stops and no further data is collected. It is the programmer's responsibility to clean up all inprocess control block resources. To restart the operation, the input stream of the module must be armed and started again.

[Figure 8](#) illustrates continuous acquisition mode using three channels: analog input channels 0 and 1 and the digital input port. When the start trigger is detected, samples from the specified channels are acquired continuously.

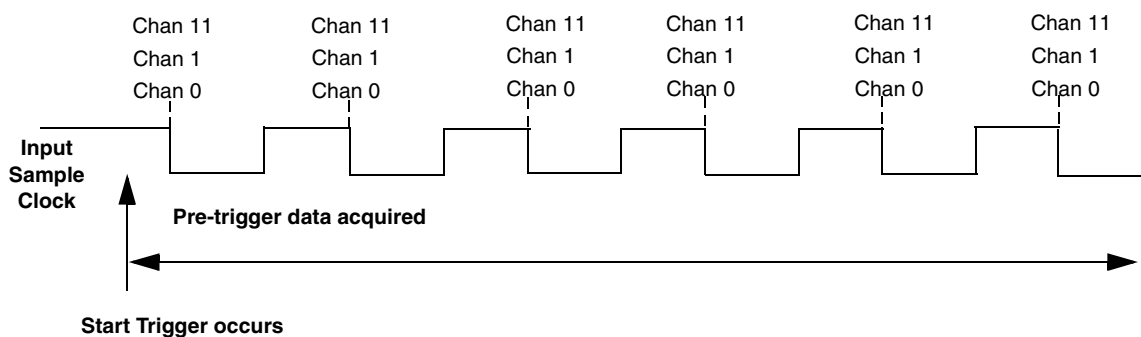

Figure 8: Continuous Sampling Mode on the DT7816 Module

Input Triggers

A trigger is an event that occurs based on a specified set of conditions. For continuous sampling mode of the channels in the input data stream, described on [page 26](#), you must specify a start trigger to start acquisition.

The DT7816 module supports the following sources for the start trigger; you configure the trigger source and its parameters using software:

- **Software trigger** – A software trigger event occurs when you start the analog input operation (the computer issues a write to the module to begin conversions). Using software, specify the start trigger source as a software trigger.
- **External digital (TTL) trigger** – An external digital (TTL) trigger event occurs when the module detects a rising- or falling-edge transition on the signal connected to a general-purpose input pin on the Digital I/O header (Refer to [page 76](#) for the pin descriptions of the Digital I/O header.) You can specify which edge is active using software.
- **Threshold trigger** – The start trigger event occurs when the signal attached to a specified analog input channel rises above or falls below a user-specified threshold value. Using software, you specify the following parameters:
 - Edge – Specify a rising-edge threshold trigger if you want to trigger when the signal rises above a threshold level, or a falling-edge threshold trigger if you want to trigger when the signal falls below a threshold level.
 - Threshold channel – Specify any one of the analog input channels as the threshold input channel.
 - Threshold level – Specify a value between ± 10 V as the threshold level. Note that in software, this value must be entered as counts.

To convert volts to raw counts, use this formula:

$$\text{counts} = ((\text{volts}/10.0f) * (1 << (16 - 1)))$$

To convert raw counts to volts, use this formula:

$$\text{volts} = ((\text{counts} * 10.0f) / (1 \ll (16 - 1)))$$

Note: The DT7816 driver sets the threshold level as close as possible to the value that you specify. However, the value that you specify may not be the actual value that is set. You can return the actual threshold level that was set using software.

If you are using a threshold trigger and an external clock, ensure that the external clock is free running for proper triggering.

Input Clock Source and Sampling Frequency

The DT7816 module supports both an internal A/D clock, which is derived from the 48 MHz reference clocked that is generated from the onboard oscillator, and an external A/D clock, which can be connected to one of the general-purpose input signals on the Digital I/O header. Refer to [page 76](#) for the pin descriptions of the Digital I/O header.

Using software, you specify the frequency at which to pace input operations. If using the internal A/D clock, the sampling frequency can range from 100 Hz to 400 kHz. If using an external A/D clock, the maximum sampling frequency is 400 kHz; there is no minimum sampling frequency.

The DT7816 driver sets the sampling frequency as close as possible to the value that you specify. However, the value that you specify may not be the actual value that is set. You can return the actual sampling frequency that was set using software.

Notes: According to sampling theory (Nyquist Theorem), specify a frequency that is at least twice as fast as the input's highest frequency component. For example, to accurately sample a 20 kHz signal, specify a sampling frequency of at least 40 kHz to avoid aliasing.

If you are using a threshold trigger and an external clock, ensure that the external clock is free running for proper triggering.

Input FIFO and Data Format

The DT7816 has an input FIFO of 16 kSamples (32 kBytes) for storing input data. The driver moves the data from the input FIFO into user-allocated buffers. Refer to the *DT7816 File I/O Programming Manual* for details on user buffers.

The data that is returned in the input buffer is in the following order, assuming that all channels are enabled in the input stream:

- Analog input channels 0 through 7. Each analog input sample is a 16-bit, two's complement, raw A/D value.
- Tachometer. This is a 32-bit unsigned value.

- Measure counter. This is a 32-bit unsigned value.
- Digital input port. This is a 16-bit unsigned value, where the digital input data is in the least significant eight bits.

If a channel is not enabled, the location in the input buffer is occupied by the data for next enabled channel in the input stream.

Error Conditions

The DT7816 module will detect an overrun error if the user buffers are not being sent to the module fast enough, and the A/D converters run out of user buffers to fill. To avoid this error, try one or more of the following:

- Reduce the clock rate of the A/D
- Increase the size of the buffers
- Increase the number of buffers
- Close any other applications that are running

Analog Output Features

This section describes the following features of analog output operations:

- Analog output channels, described below
- Output ranges and gains, described below
- Output resolution, described below
- Output clocks, described below
- Output conversion mode, described on [page 31](#)
- Output triggers, described on [page 32](#)
- Data format and transfer, described on [page 32](#)
- Error conditions, described on [page 32](#)

Analog Output Channels

The DT7816 module supports two analog output channels (0 and 1) that can be updated simultaneously. In addition to the analog output channels, you can update the individual lines of the digital output port in the output stream, if desired. Refer to [page 31](#) for more information.

The analog output channels power up to a value of $0\text{ V} \pm 10\text{ mV}$.

Output Range and Gain

The DT7816 module supports an output range of $\pm 10\text{ V}$. A fixed gain of 1 is used.

Output Resolution

The resolution of the analog output channel is fixed at 16 bits; you cannot specify the resolution in software.

Output Clocks

The DT7816 module supports both an internal D/A clock, which is derived from the 48 MHz reference clock that is generated from the onboard oscillator, and an external D/A clock that you can connect to one of the general-purpose input signals of the Digital I/O header (see [page 76](#) for the pin assignments of the Digital I/O header).

Using software, you specify the frequency at which to update the channels in the output stream. If using the internal D/A clock, the output frequency can range between 1 Hz and 400 kHz. If using the external D/A clock, the maximum output frequency is 400 kHz; there is no minimum frequency.

Note: To synchronize the A/D and D/A subsystems, use the same external clock source for both subsystems.

Output Conversion Modes

The DT7816 module support single-value and continuous analog output operations.

Single-Value Mode

In single-value mode, use software to specify the analog output channel that you want to update, and the value to output from that channel. The value is output from the specified channel immediately.

You cannot specify a clock frequency, trigger source, or buffer for a single-value operation. Single-value operations stop automatically when finished; you cannot stop a single-value operation.

Continuous Analog Output Operations

Use continuous analog output mode to update the analog output channels in the output stream. You can also use this mode to update the individual digital output lines of the digital output port in the output stream.

In software, you specify the channel mask for the output stream to determine which channels to update. The bits of the channel mask are as follows:

- Channels (bits) 16 and 17 – Analog output channels 0 and 1
- Channel (bit) 24 to 31 – Digital output lines 0 to 7; refer to [page 46](#) for more information

Using software, you create a buffer with the values that you want to output to the analog output channels and/or the digital output lines.

When it detects a trigger, the module starts writing the values from the output buffer to the channels specified in the output stream at the specified clock frequency. The operation repeats continuously until all the data is output from the buffers or you stop the operation.

The DT7816 module supports the ability to start continuous operations on the output stream and input stream at the same time.

Note: Make sure that the data is transferred from the buffer to the output stream fast enough so that the channel does not run out of data; otherwise, an underrun error results.

To stop a continuously paced analog output operation, you can stop queuing buffers for the analog output system, letting the module stop when it runs out of data, or you issue a command to stop the continuous output operation.

Output Trigger

The DT7816 module supports the following trigger sources for starting operations on the output stream:

- **Software trigger** – A software trigger event occurs when you start the analog output operation (the computer issues a write to the module to begin conversions). Using software, specify the trigger source for the D/A subsystem as a software trigger.
- **External digital (TTL) trigger** – An external digital (TTL) trigger event occurs when the module detects a rising- or falling-edge transition on the signal connected to a general-purpose input pin on the Digital I/O header. (Refer to [page 76](#) for more the pin descriptions of the Digital I/O header.) You can specify which edge is active using software.

Output FIFO and Data Format

The DT7816 has an output FIFO of 8 kSamples (16 kBytes) for storing output data. The driver moves the data from user-allocated buffers into the output FIFO on the module. Refer to the *DT7816 File I/O Programming Manual* for details on user buffers.

The data in the output buffer must be in the following order, assuming that all channels are enabled in the output stream:

- Analog output channels 0 and 1. Each analog output sample is a 16-bit, two's complement, raw D/A value.
- Digital output port. This is a 16-bit unsigned value, where the digital output data is in the least significant eight bits.

If a channel is not enabled, the location in the output buffer is occupied by the data for next enabled channel in the output stream.

Error Conditions

The DT7816 module can detect underrun errors, where the D/A converter runs out of data when the data buffers are not being sent to the output stream fast enough. To avoid this error, try reducing the clock rate of the analog output operation.

Tachometer Input Features

You can connect a tachometer signal with a range of ± 30 V to pin 1 of the Digital Function header on the module. Refer to [page 80](#) for the pin descriptions of the Digital Function header. Refer to the *DT7816 Getting Started* help file for wiring information.

The tachometer input accepts signals with a maximum frequency of 1 MHz and a minimum pulse width of 0.4 μ s. The threshold voltage is fixed at +2 V with 0.5 V of hysteresis.

You can measure the frequency or period of the tachometer input signal to calculate the rotation speed for high-level (± 30 V) tachometer input signals. An internal 12 MHz counter is used for the measurement, yielding a resolution of 83 ns (1/12 MHz).

You can read the number of counts between two consecutive starting edges of the tachometer input signal by specifying bit 8 in the channel mask for the input stream. The starting edge is programmable (either rising or falling).

Using software, you can also specify a flag (called Stale) that indicates whether or not the data is new. If the Stale flag is set as Used (the default value), the most significant bit (MSB) of the value is set to 0 to indicate new data; reading the value before the measurement is complete returns an MSB of 1. If the Stale flag is set to Not Used, the MSB is always set to 0.

When the input operation is started, the internal 12 MHz counter starts incrementing when it detects the first starting edge of the tachometer input and stops incrementing when it detects the next starting edge; at that point, the counter stores the count. The stored count is maintained until it is read as part of the input data stream or until a new count is stored. The next tachometer measurement operation is started automatically.

If the sample rate of the input subsystem is faster than the tachometer input frequency, then the stored count retains the current value when the count is read by the input subsystem. The operation of the Stale flag in this case is described as follows:

- If another input subsystem sample occurs before another measure completes and the Stale flag is enabled, then the Stale flag is set and the stale measure count is written into the input data stream.
- If another input subsystem sample occurs before another measure completes and the Stale flag is disabled, then the Stale flag is not set and the stale measure count is written into the input data stream.

If the input sample rate is slower than the tachometer input frequency, then as each period measurement completes, a new count value is stored. When the input subsystem sample occurs, the most recently stored measure count is written into the input data stream.

A data pipeline is used in the hardware to compensate for the A/D group delay and synchronizes the value of the tachometer input with the analog input measurements so that all measurements are correlated in time. The tachometer input is treated like any other channel in the analog input channel list; therefore, all the triggering and conversion modes supported for analog input channels are supported for the tachometer input.

When you read the value of the tachometer input as part of the analog input data stream, you might see results similar to the following:

Table 1: An Example of Reading the Tachometer Input as Part of the Analog Input Data Stream

Time	A/D Value	Tachometer Input Value	Status of Operation
10	5002	0	Operation started, but is not complete
20	5004	0	Operation not complete
30	5003	0	Operation not complete
40	5002	12373	Operation complete
50	5000	12373	Next operation started, but is not complete
60	5002	12373	Operation not complete
70	5004	12373	Operation not complete
80	5003	14503	Operation complete
90	5002	14503	Next operation started, but is not complete

Using the count that is returned from the tachometer input, you can determine the following:

- Frequency of a signal pulse (the number of periods per second). You can calculate the frequency as follows:
 - $\text{Frequency} = 12 \text{ MHz} / (\text{Number of counts} - 1)$
where 12 MHz is the internal counter/timer clock frequency

For example, if the count is 21, the measured frequency is 600 kHz (12 MHz/20).
- Period of a signal pulse. You can calculate the period as follows:
 - $\text{Period} = 1 / \text{Frequency}$
 - $\text{Period} = (\text{Number of counts} - 1) / 12 \text{ MHz}$
where 12 MHz is the internal counter/timer clock frequency

General-Purpose Counter/Timer Features

This section describes the following features of counter/timer (C/T) operations:

- C/T channels, described below
- C/T clock sources, described on [page 36](#)
- Gate types, described on [page 36](#)
- Pulse output period and duty cycle, described on [page 37](#)
- C/T operation modes, described on [page 38](#)

Refer to the *DT7816 Getting Started* help file for wiring information.

C/T Channels

DT7816 modules provide one 32-bit, general-purpose counter/timer (C/T 0). As shown in [Figure 9](#), the counter/timer accepts a clock input and gate input signal and outputs a pulse (clock output signal).

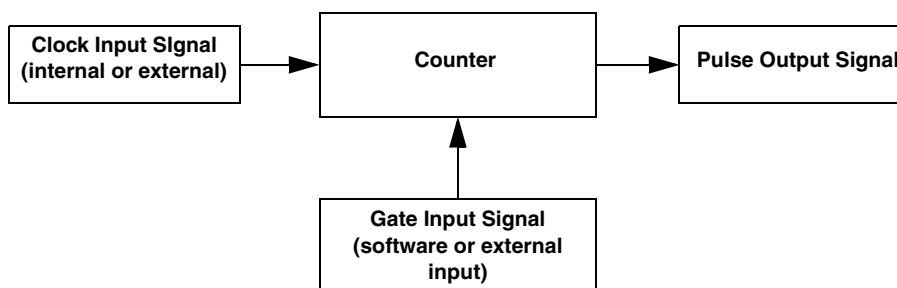

Figure 9: Counter/Timer Channel

Using software, you define general-purpose I/O pins on the Digital I/O header for the external C/T clock input, external C/T gate input, and C/T clock output signals. Refer to [page 76](#) for the pin assignments of the Digital I/O header. Refer to the *DT7816 Getting Started* help file for wiring information.

C/T Clock Input Sources

The following clock input sources are available for the general-purpose counter/timer; you select the clock source through software:

- **Internal C/T clock** – The internal C/T clock uses a 48 MHz time base. This clock source is typically used for one-shot and rate generation operations.
- **External C/T clock** – An external C/T clock is useful when you want to pace counter/timer operations at rates not available with the internal C/T clock or if you want to pace at uneven intervals. The frequency of the external C/T clock can range from 0.0112 Hz to 10 MHz.

This clock source is typically used for event counting and rate generation operations.

Using software, specify one of the general-purpose input pins of the Digital I/O header on the DT7816 module as the external C/T clock input. Then, physically connect the external clock signal to the selected pin. (Refer to [page 76](#) for the pin descriptions of the Digital I/O header.) Counter/timer operations start on the rising edge of the clock input signal.

Gate Types

The edge or level of the counter gate signal determines when a counter/timer operation is enabled.

Unless you are using a software gate (no gate), define one of the general-purpose input pins of the Digital I/O header on the DT7816 module as the external C/T gate input using software. Then, physically connect the external gate signal to the selected pin. (Refer to [page 76](#) for the pin descriptions of the Digital I/O header.)

DT7816 modules provide the following gate types; you select the gate type using software:

- **None** – A software start command enables any counter/timer operation immediately after execution. (No general-purpose input signal is required if a gate type of None is selected.)
- **Low external gate input** – Specifies a logic low or falling edge gate type. For event counting and rate generation mode, the operation is enabled when the counter's gate signal is low and is disabled when the counter's gate signal is high. For one-shot mode or repetitive one-shot mode, the operation is enabled when the counter's gate signal goes from a high to a low transition and is disabled when the counter's gate signal goes from a low to a high transition.

You specify one of the general-purpose input pins of the Digital I/O header on the DT7816 module as the external C/T gate input. Ensure that you physically connect the external gate signal to the selected pin. (Refer to [page 76](#) for the pin descriptions of the Digital I/O header.)

- **High external gate input** – Specifies a logic high or rising edge gate type. For event counting and rate generation mode, the operation is enabled when the counter's gate signal is high and is disabled when the counter's gate signal is low. For one-shot mode or repetitive one-shot mode, the operation is enabled when the counter's gate signal goes from a low to a high transition and is disabled when the counter's gate signal goes from a high to a low transition.

You specify one of the general-purpose input pins of the Digital I/O header on the DT7816 module as the external C/T gate input. Ensure that you physically connect the external gate signal to the selected pin. (Refer to [page 76](#) for the pin descriptions of the Digital I/O header.)

Pulse Output Period, Pulse Width, and Polarity

If you want to perform a C/T output operation, define one of the general-purpose output pins of the Digital I/O header on the DT7816 module as the external C/T output signal using software. Then, connect the external C/T output signal to the selected pin. (Refer to [page 76](#) for the pin descriptions of the Digital I/O header.)

For the DT7816 module, you can program the polarity of the output pulse (active high or active low). For an active high pulse, the high portion of the total pulse output period is the active portion of the counter/timer pulse output signal. For an active low pulse, the low portion of the total pulse output period is the active portion of the counter/timer pulse output signal.

Using software, you can specify the number of input clock cycles that are used to create one period of the counter clock output signal. You can also specify the number of input clock cycles used to create the active pulse width (or duty cycle) of the C/T output signal.

For example, if you are using an external C/T clock running at 10000 Hz as the input clock source of the counter/timer, and you want to generate a output signal of 1000 Hz with a 20% duty cycle, specify a period of 10 (10000 Hz divided by 10 is 1000 Hz) and a pulse width of 2 (the period of 10 multiplied by 20%). This is illustrated in [Figure 10](#).

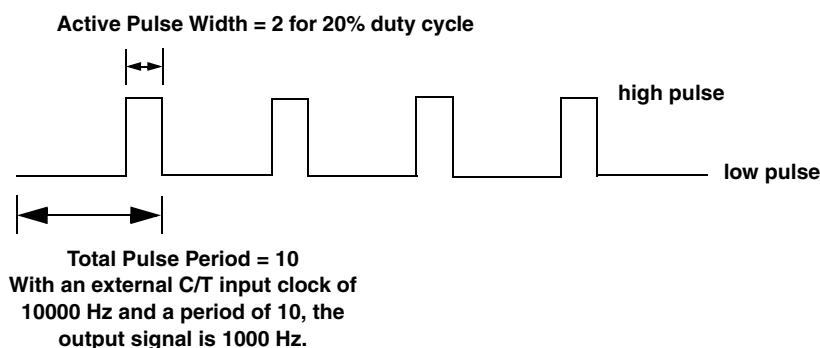

Figure 10: Example of a Pulse Output

Note: If you are using an internal C/T clock input source, you can output pulses using a maximum frequency of 24 MHz. Note, however, that the integrity of the signal degrades at frequencies greater than 10 MHz.

If you are using an external C/T clock input source, you can output pulses using a maximum frequency of 5 MHz.

Counter/Timer Operation Modes

The general-purpose counter/timer on the DT7816 module supports the following counter/timer operation modes:

- Event counting
- Rate generation
- Non-retriggerable one-shot
- Idle

The following subsections describe these modes in more detail.

Event Counting

Use event counting mode if you want to count the number of rising edges that occur on the counter's clock input when the counter's gate signal is active (low-level or high-level).

You can count a maximum of 4,294,967,296 events before the counter rolls over to 0 and starts counting again.

Note: The count is returned as a 32-bit unsigned value.

Using software, you must specify the following parameters for the event counting operation:

- Active gate type (external low level or external high level). Refer to [page 36](#) for more information about the supported gate types.
- The general-purpose input pin to use for the external gate signal. Ensure that you physically connect the gate signal to this input pin. Refer to [page 76](#) for the pin descriptions of the Digital I/O header.
- The C/T clock source (internal or external). Note that in event counting mode, the external C/T clock is more useful than an internal C/T clock; refer to [page 36](#) for more information about the C/T clock sources.
- The general-purpose input pin to use for the external C/T clock input. Ensure that you physically connect the clock input signal to this input pin. Refer to [page 76](#) for the pin descriptions of the Digital I/O header.

Using software, you can synchronously read the value of the counter.

Rate Generation

Use rate generation mode to generate a continuous pulse output signal from the counter's output signal. You can use this pulse output signal as an external clock to pace other operations, such as an analog input or other counter/timer operations.

The pulse output operation is enabled whenever the counter's gate signal is at the specified level. While the pulse output operation is enabled, the counter outputs a pulse of the specified type and frequency continuously. As soon as the operation is disabled, rate generation stops.

You can output pulses using a maximum frequency of 24 MHz (if using the internal C/T clock) or 5 MHz (if using the external C/T clock).

Note: The integrity of the signal degrades at frequencies greater than 10 MHz.

Using software, you must specify the following parameters for the rate generation operation:

- Active gate type (external low level or external high level). Refer to [page 36](#) for more information about the supported gate types.
- The general-purpose input pin to use for the external gate signal. Ensure that you physically connect the gate signal to this input pin. Refer to [page 76](#) for the pin descriptions of the Digital I/O header.
- The C/T clock source (internal or external). Refer to [page 36](#) for more information about the C/T clock sources.
- If you are using an external C/T clock source, the general-purpose input pin to use for the external C/T clock input. Ensure that you physically connect the clock input signal to this input pin. Refer to [page 76](#) for the pin descriptions of the Digital I/O header.
- The period of the output pulse. Refer to [page 37](#) for more information about the period of the output pulse.
- The pulse width (duty cycle) of the active pulse. Refer to [page 37](#) for more information about the pulse width of the output pulse.
- The general-purpose output signal to use for the C/T clock output signal. Ensure that you physically connect the C/T output signal to this output pin. Refer to [page 76](#) for the pin descriptions of the Digital I/O header.
- The polarity of the output signal (active high or active low). Refer to [page 37](#) for more information on the polarity of the output pulse.

Non-Retriggerable One-Shot

Use non-retriggerable one-shot mode to generate a single output pulse from the counter whenever the specified edge is detected on the counter's gate signal (after the pulse period from the previous output pulse expires). Any gate signals that occur while the pulse is being output are not detected by the module, as shown in [Figure 11](#). The module continues to output a pulse when the specified gate edge is detected until you stop the operation. You can use this mode to clean up a poor clock input signal by changing its pulse width, and then outputting it.

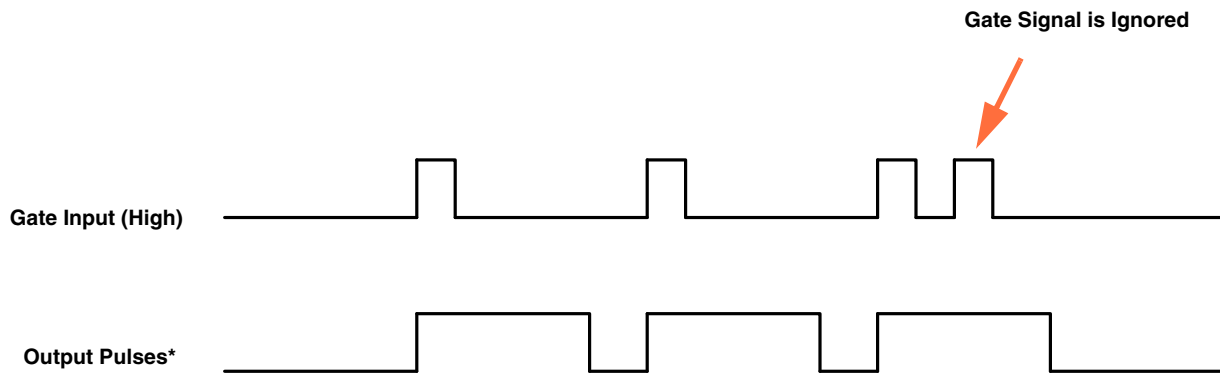

*You can determine period, pulse width, and polarity of the output pulse using software.

Figure 11: Non-Retriggerable One-Shot Mode

Using software, you must specify the following parameters for the non-retriggerable one-shot operation:

- Active gate type that enables the operation. Refer to [page 36](#) for more information about the supported gate types.
- The general-purpose input pin to use for the external gate signal. Ensure that you physically connect the gate signal to this input pin. Refer to [page 76](#) for the pin descriptions of the Digital I/O header.
- The C/T clock source (internal or external) that generates the pulse. Note that in one-shot mode, the internal C/T clock is more useful than an external C/T clock; refer to [page 36](#) for more information about the C/T clock sources.
- The general-purpose input pin to use for the external C/T clock input. Ensure that you physically connect the clock input signal to this input pin. Refer to [page 76](#) for the pin descriptions of the Digital I/O header.
- The period of the output pulse. Refer to [page 37](#) for more information about the period of the output pulse.
- The pulse width (duty cycle) of the active pulse. Refer to [page 37](#) for more information about the pulse width of the output pulse.

- The general-purpose output signal to use for the C/T clock output signal. Ensure that you physically connect the C/T output signal to this output pin. Refer to [page 76](#) for the pin descriptions of the Digital I/O header.
- The polarity of the output signal (active high or active low). Refer to [page 37](#) for more information on the polarity of the output pulse.
- Retriggerable setting of 0 for non-retriggerable one-shot.

Idle Mode

If you use idle mode, the counter no longer drives the clock output signal that is assigned to one of the general-purpose output signals of the Digital I/O header. Refer to [page 76](#) for the pin descriptions of the Digital I/O header.

Note: The value of the counter output signal can also be overwritten by writing to the digital output subsystem.

If you assigned a general-purpose input signal as a counter clock or gate input (or external trigger), you can read the value of the signal as you would any other digital input signal. |

Refer to [page 46](#) for more information on digital I/O operations.

Measure Counter Features

DT7816 modules provide one measure counter. Using this counter, you can measure the frequency, period, or pulse width of a single signal or the time period between two signals and return the value in the analog input stream. This is useful for correlating the analog input data with digital positional data, measuring the frequency of a signal, or as a tachometer. An internal 48 MHz counter is used for the measurement, yielding a resolution of 20.83 ns (1/48 MHz).

To read the value of measure counter in the input stream, specify bit 10 in the channel mask of the input stream.

Using software commands, you can configure the following parameters for the measure counter:

- The signals that start and stop the measurement. Refer to [Table 2](#) for the supported start and stop signals.

Table 2: Possible Start and Stop Signals

Signal	Connection Required
A/D conversion complete	No connection required.
Tachometer input (falling edge or rising edge)	Connect to Tachometer input.
Digital input 0 (falling edge or rising edge)	Connect a digital input, external A/D trigger, C/T clock input, or C/T gate input to general-purpose input 0 (pin 1) of the Digital I/O header. By default, this is digital input 0.
Digital input 1 (falling edge or rising edge)	Connect a digital input, external A/D trigger, C/T clock input, or C/T gate input to general-purpose input 1 (pin 3) of the Digital I/O header. By default, this is digital input 1.
Digital input 2 (falling edge or rising edge)	Connect a digital input, external A/D trigger, C/T clock input, or C/T gate input to general-purpose input 2 (pin 5) of the Digital I/O header. By default, this is digital input 2.
Digital input 3 (falling edge or rising edge)	Connect a digital input, external A/D trigger, C/T clock input, or C/T gate input to general-purpose input 3 (pin 7) of the Digital I/O header. By default, this is digital input 3.
Digital input 4 (falling edge or rising edge)	Connect a digital input, external A/D trigger, C/T clock input, or C/T gate input to general-purpose input 4 (pin 9) of the Digital I/O header. By default, this is digital input 4.
Digital input 5 (falling edge or rising edge)	Connect a digital input, external A/D trigger, C/T clock input, or C/T gate input to general-purpose input 5 (pin 11) of the Digital I/O header. By default, this is digital input 5.
Digital input 6 (falling edge or rising edge)	Connect a digital input, external A/D trigger, C/T clock input, or C/T gate input to general-purpose input 6 (pin 13) of the Digital I/O header. By default, this is digital input 6.
Digital input 7 (falling edge or rising edge)	Connect a digital input, external A/D trigger, C/T clock input, or C/T gate input to general-purpose input 7 (pin 15) of the Digital I/O header. By default, this is digital input 7.

- A flag (called Stale) indicating whether or not the data is new. This flag is used only when the start edge and the stop edge is set to use the same pin and edge.

If the Stale flag is set as Used (the default value), the most significant bit (MSB) of the value is set to 0 to indicate new data; reading the value before the measurement is complete returns an MSB of 1. If the Stale flag is set to Not Used, the MSB is always set to 0.

When the selected start edge is the same as the selected stop edge, the internal 48 MHz counter starts incrementing when it detects the first start edge of the selected input signal and stops incrementing when it detects the selected stop edge (which is the same as the start edge, in this case); at that point, the counter stores and resets the count. The stored count is maintained until it is read as part of the input data stream or until a new count is stored. Since the stop edge is the same as the start edge in this case, the stop edge for the current measurement is the start edge for the next measurement; therefore, no waveform periods are missed. The value of the measure count depends on the input subsystem sample frequency, described as follows:

- If the input subsystem sample frequency is faster than the selected input frequency, then the stored measure count retains the current value when it is read by the input subsystem. The operation of the Stale flag in this case is described as follows:
 - If another input subsystem sample occurs before another measure completes and the Stale flag is used, then the Stale flag is set and the stale measure count is written into the input data stream.
 - If another input subsystem sample occurs before another measure completes and the Stale flag is not used, then the Stale flag is not set and the stale measure count is written into the input data stream.
- If the input subsystem sample frequency is slower than the selected input frequency, then the new measure count value is stored as each period measurement completes. When an input subsystem sample occurs, then the most recently stored measure count is written into the input data stream.

When the selected start edge is not the same as the selected stop edge, the internal 48 MHz counter starts incrementing when it detects the selected start edge and stops incrementing when it detects the next selected stop edge; at that point, the counter stores and resets the count. The stored count is maintained until it is read as part of the input data stream or until a new count is stored. The value of the measure count depends on the input subsystem sample frequency, described as follows:

- If the input subsystem sample rate is faster than the selected measurement period, then the stored count retains the current value when the count is read by the input subsystem. The operation of the Stale flag in this case is described as follows:
 - If another input subsystem sample occurs before another measure completes and the Stale flag is used, then the Stale flag is set and the stale measure count is written into the input data stream.
 - If another input subsystem sample occurs before another measure completes and the Stale flag is not used, then the Stale flag is not set and the stale measure count is written into the input data stream.

- If the input subsystem sample rate is slower than the selected measurement period, then a new count value is stored as each period measurement completes. When an input subsystem sample occurs, the most recently stored measure count is written into the input data stream.

A data pipeline is used in the hardware to compensate for the A/D group delay and synchronizes the value of the measure counter with the analog input measurements, so that all measurements are correlated in time. The measure counter is treated like any other channel in the analog input channel list; therefore, all the triggering and conversion modes supported for analog input channels are supported for the measure counter.

When you read the value of the measure counter as part of the analog input data stream, you might see results similar to the following:

Table 3: An Example of Reading a Measure Counter as Part of the Analog Input Data Stream

Time	A/D Value	Measure Counter Values	Status of Operation
10	5002	0	Operation started, but is not complete
20	5004	0	Operation not complete
30	5003	0	Operation not complete
40	5002	12373	Operation complete
50	5000	12373	Next operation started, but is not complete
60	5002	12373	Operation not complete
70	5004	12373	Operation not complete
80	5003	14503	Operation complete
90	5002	14503	Next operation started, but is not complete

Using the count that is returned from the measure counter, you can determine the following:

- Frequency between the start and stop signals/edges. You can calculate the frequency as follows:
 - $\text{Frequency} = 48 \text{ MHz} / (\text{Number of counts} - 1)$
where 48 MHz is the internal measure counter frequency

For example, if the count is 201, the measured frequency is 240 kHz (48 MHz/200).
- Period between the start and stop signals/edges. You can calculate the period as follows:
 - $\text{Period} = 1 / \text{Frequency}$
 - $\text{Period} = (\text{Number of counts} - 1) / 48 \text{ MHz}$
where 48 MHz is the internal measure counter frequency

- Pulse width of the start and stop signal/edges (rising to falling edge or falling edge to rising edge). You can calculate the period as follows:
 - Pulse width = $1/\text{Frequency}$
 - Pulse width = $(\text{Number of counts} - 1)/48 \text{ MHz}$
where 48 MHz is the internal measure counter frequency

Digital I/O Features

This section describes the following features of digital I/O operations:

- Digital I/O lines
- Operation modes

Digital I/O Lines

DT7816 modules support one digital input port, consisting of up to 8 digital input lines (lines 0 to 7) and one digital output port, consisting of up to 8 digital output lines (lines 0 to 7). The resolution is fixed at 8 bits.

You can access these signals through the 34-pin Digital I/O header on the module. Refer to [page 76](#) for the pin descriptions of the Digital I/O header.

Note: A single general-purpose input signal on the Digital I/O header may drive several destinations at the same time. However, a single general-purpose output can have only one driving source.

If you assigned a general-purpose input signal as a counter clock or gate input or as an external trigger or external clock, you can read the value of the signal as you would any other digital input signal, if desired.

If you want to write a value to a specific digital output line, ensure that the corresponding pin of the Digital I/O header is not configured for another use (such as the output of the counter/timer) or you could corrupt the signal on the pin.

A digital line is high if its value is 1; a digital line is low if its value is 0. On power up or reset, a low value (0) is output from each of the digital output lines and a high value (1) is read from each of the digital input lines if the lines are not connected.

Refer to the *DT7816 Getting Started* help file for wiring information.

Operation Modes

DT7816 modules support the following digital I/O operation modes:

- **Synchronous read and write operations** – Using software, you can read the value of the digital input port using a synchronous read operation or write a value to the digital output port using a synchronous write operation. The operation is blocking, in that it does not return until the value is read or written.

You do not specify a trigger or clock for a synchronous read or write operation. The operation stops automatically once the value is read or written.

- **Continuous digital input** – Using software, specify the digital input port as bit 11 of the channel mask for the input stream. You can specify the sampling frequency and trigger source for the input stream. The trigger starts the acquisition. The input sample clock paces the acquisition of data from the digital input port as well as the analog input channels, tachometer input, general-purpose counter/timer, and/or the measure counter.
- **Continuous digital output** – Using software, specify the individual lines of the digital output port as bits 24 to 31 of the channel mask for the output stream. You can specify the sampling frequency and trigger source for the output stream. The trigger starts the output operation. The output sample clock determines the rate at which the digital output port and the analog output channel are updated.

Synchronizing Acquisition on Multiple Modules

By using an external clock source, you can synchronize the clocks on multiple modules. In addition, you can start acquisition on multiple modules by connecting all modules to a shared external trigger input. [Figure 12](#) shows the connections.

Using software, you must define one of the general-purpose input pins on the Digital I/O header on each DT7816 module as the external trigger signal and another general-purpose input pin on the Digital I/O header on each DT7816 module as the external clock signal. Refer to [page 76](#) for the pin assignments of the Digital I/O header.

When triggered, the modules start acquiring data at the same time at the frequency of the external clock source.

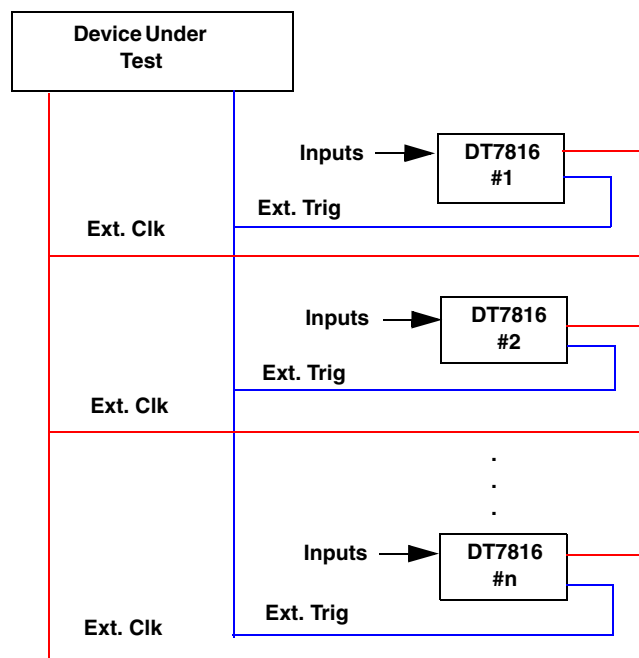

Figure 12: Synchronizing Multiple Modules Using an External Clock and External Trigger

Note: If you want to synchronize the analog input and analog output subsystems, connect the same external clock source to both the analog input and analog output subsystems, and connect the same external trigger source to both the analog input and analog output subsystems.



Troubleshooting

Technical Support	50
If Your Module Needs Factory Service	51

Technical Support

Should you experience problems using the DT7816 module, follow these steps:

1. Read all the appropriate sections of this manual and the *DT7816 File I/O Programming Manual*.
2. Refer to the supplied example programs for clarification.
3. Check that you have installed your hardware devices properly.
4. Check that you have installed the software properly.

If you are still having difficulty using the DT7816 module, Data Translation's Technical Support Department is available to provide technical assistance.

To request technical support, go to our web site at <http://www.datatranslation.com> and click on the Support link.

When requesting technical support, be prepared to provide the following information:

- Your product serial number
- The hardware/software product you need help on

If you are located outside the USA, contact your local distributor; see our web site (www.datatranslation.com) for the name and telephone number of your nearest distributor.

If Your Module Needs Factory Service

If your module must be returned to Data Translation, do the following:

1. Record the module's serial number, and then contact the Customer Service Department at (508) 481-3700, ext. 1323 (if you are in the USA) and obtain a Return Material Authorization (RMA).

If you are located outside the USA, call your local distributor for authorization and shipping instructions; see our web site (www.datatranslation.com) for the name and telephone number of your nearest distributor. All return shipments to Data Translation must be marked with the correct RMA number to ensure proper processing.

2. Using the original packing materials, if available, package the module as follows:
 - Wrap the module in an electrically conductive plastic material. Handle with ground protection. A static discharge can destroy components on the module.
 - Place in a secure shipping container.
3. Return the module to the following address, making sure the RMA number is visible on the outside of the box.

Customer Service Dept.
Data Translation, Inc.
100 Locke Drive
Marlboro, MA 01752-1192



Calibration

Overview	54
Calibrating the Analog Input Subsystem	55
Calibrating the Analog Output Subsystem	56

Overview

DT7816 modules are calibrated at the factory and should not require calibration for initial use. We recommend that you check and, if necessary, readjust the calibration of the analog circuitry every six months using the DT7816 calibration example, provided as a command-line program (**DT7816cal**).

This chapter describes how to calibrate the analog circuitry of a DT7816 module using this program.

Calibrating the Analog Input Subsystem

The input range of ± 10 V for all channels on the DT7816 is established by a single 5 V onboard reference circuit. The overall accuracy of the measurements is affected by the gain and offset errors of each channel. The offset errors are low enough that no offset correction circuitry is provided on the module. However, the gain error must be corrected by trimming the 5 V reference; a digital potentiometer is provided on the module for this purpose. Varying the 5 V reference has the effect of scaling the input range above or below the ± 10 V nominal voltage.

The DT7816 calibration example calibrates the voltage reference of analog input channel 0 based on the average value of all eight analog input channels to minimize the error from any one channel. The accuracy of the remaining channels is dependent on the channel-to-channel matching of the ADC device, which is typically within 0.2%.

Note: An external, precision voltage source is required to calibrate the analog input circuitry of the DT7816.

To calibrate the analog input circuitry, perform the following steps:

1. From the `/usr/local/bin/dt78xx-examples/dt7816-calibration/release` directory on the module, enter the following command:

```
./dt7816cal ain
```
2. Short analog input channels 0 through 7 to analog ground.
3. Press **Enter** to continue.
The program acquires a block of 1000 samples from analog input channels 0 to 7 at a sampling frequency of 200 kHz and computes the average ADC count value. This value (shown as an offset and count) is displayed.
4. Remove the shorting terminations and connect a precision voltage source of +9.000 V to analog input channels 0 to 7.
5. Press **Enter** to continue.
The program acquires and averages a block of data and sequentially adjusts the gain potentiometer for the analog input channels until the target value, which is 0x72AE (29358 decimal) + the offset value, is reached. The voltage values, count, and wiper values are displayed.

Once the analog input circuitry is calibrated, the program terminates automatically. If you wish to exit the program before the calibration process is finished, press **Ctrl-c**.

Calibrating the Analog Output Subsystem

Each analog output channel on the DT7816 module requires offset and gain calibration using onboard potentiometers. The gain calibration must be done before the offset calibration.

Note: An external, precision digital multimeter (DMM) or voltmeter (DVM) is required to calibrate the analog output circuitry of the DT7816.

To calibrate the analog output circuitry, perform the following steps:

1. From the `/usr/local/bin/dt78xx-examples/dt7816-calibration/release` directory on the module, enter the following command:

```
./dt7816cal aout
```
2. Connect a DMM to analog output channel 0.
The DT7816 outputs a value of -9.9 V.
3. Note the voltage that is reported on the DMM to the nearest 10 μ V.
4. Press any key to continue.
The DT9816 outputs a value of +9.9 V.
5. Adjust the gain until the magnitude of the reading on the DMM is within 10 μ V of 19.8 V plus the value that was noted in step 3. For coarse adjustments, press **U** to go up or **D** to go down in value. For fine adjustments, press **u** to go up or **d** to go down in value.
6. When the gain is adjusted, press **s** to save the calibration.
A message is displayed indicating that the calibration was saved. Then, the DT7816 outputs a value of 0 V.
7. Adjust the offset until the reading on the DMM is within 10 μ V of 0 V. For coarse adjustments, press **U** to go up or **D** to go down in value. For fine adjustments, press **u** to go up or **d** to go down in value.
8. When the offset is adjusted, press **s** to save the calibration.
A message is displayed indicating that the calibration was saved.
9. Connect a DMM to analog output channel 1.
The DT7816 outputs a value of -9.9 V.
10. Note the voltage that is reported on the DMM to the nearest 10 μ V.
11. Press any key to continue.
The DT9816 outputs a value of +9.9 V.
12. Adjust the gain until the magnitude of the reading on the DMM is within 10 μ V of 19.8 V plus the value that was noted in step 10. For coarse adjustments, press **U** to go up or **D** to go down in value. For fine adjustments, press **u** to go up or **d** to go down in value.
13. When the gain is adjusted, press **s** to save the calibration.
A message is displayed indicating that the calibration was saved. Then, the DT7816 outputs a value of 0 V.

14. Adjust the offset until the reading on the DMM is within 10 μV of 0 V. For coarse adjustments, press **U** to go up or **D** to go down in value. For fine adjustments, press **u** to go up or **d** to go down in value.
15. When the offset is adjusted, press **s** to save the calibration.
A message is displayed indicating that the calibration was saved.

Once the analog output circuitry is calibrated, the program terminates automatically. If you wish to exit the program before the calibration process is finished, press **Ctrl-c**.



Specifications

Analog Input Specifications	60
Analog Output Specifications	62
Digital Input Specifications	63
Digital Output Specifications	64
Tachometer Input Specifications	65
Measure Counter Specifications	66
General-Purpose Counter/Timer Specifications	67
Trigger Specifications	68
Master Oscillator Specifications	69
Power, Physical, and Environmental Specifications	70
Regulatory Specifications	71
Connector Specifications	72
External Power Supply Specifications	73

Analog Input Specifications

Table 4 lists the specifications for the analog input subsystem on the DT7816 module. Unless otherwise noted, specifications are typical at 25° C.

Table 4: Analog Input Subsystem Specifications

Feature	DT7816 Specifications
Number of analog input channels	8, single-ended
Resolution	16 bits
Input range (gain of 1)	±10 V
A/D type	SAR (successive approximation register)
Sampling mode	Simultaneous
Data encoding	Two's complement
Input FIFO	16 kSamples
Maximum sample rate	400 kS/s
Minimum sample rate	100 S/s
Analog bandwidth passband	−3 dB @ 1 MHz
Channel-to-channel crosstalk ^a Input Signal = 1 kHz: Input Signal = 10 kHz:	100 dB 90 dB
Input impedance	10 MΩ
DC Accuracy	
Offset error ^b	±0.5 mV
Offset error temperature coefficient	4 μV/° C
Gain error	±0.2% of reading
Gain error temperature coefficient	10 ppm/° C
ADC Integral Non-Linearity error, INL	2 LSB
ADC Differential Non-Linearity error, DNL	±0.75 LSB
Dynamic Performance^c	
Effective Number of Bits, ENOB ^d (1 kHz input, −1 dBFS input)	13.5 bits
Signal to Noise and Distortion Ratio, SINAD ^e (1 kHz input, −1 dBFS input)	82 dB
Signal to Noise Ratio, SNR ^f (1 kHz input, −1 dBFS input)	83 dB
Total Harmonic Distortion, THD ^g (1 kHz input, −1 dBFS input)	−95 dB

Table 4: Analog Input Subsystem Specifications (cont.)

Feature	DT7816 Specifications
Spurious Free Dynamic Range, SFDR ⁿ (1 kHz input, -1 dBFS input)	95 dBFS
Noise Floor (50 Ω input termination)	350 μ V _{RMS}
Overvoltage Protection	
Overvoltage protection (power on/off)	\pm 30 V
ESD protection Arc: Contact:	8 kV 8 kV

- a. Channel 0 is the reference channel with a -1 dBfs signal and a sample rate of 400 kSamples/s. All other channels terminated with 50 Ω resistor.
- b. Offset errors are referred to the input.
- c. ENOB, SINAD, SNR, THD, and SFDR measurements were made with a 16384 point FFT with a minimum 4-term Blackman Harris window and a 400 kS/s sample rate.
- d. Effective Number of Bits (ENOB) is calculated from the SINAD value with adjustment for level below full-scale of the input signal.

$$ENOB = \frac{(SINAD - 1.76 + IBFS)}{6.02}$$

where, IBFS is a positive value in dB, representing the ratio of a full-scale signal to the input signal.

- e. Signal to Noise and Distortion (SINAD) is the ratio of the RMS value of the input signal to the RMS sum of all other spectral components, excluding DC.
- f. Signal to Noise Ratio (SNR) is the ratio of the RMS value of the input signal to the RMS sum of all other spectral components, excluding harmonics and DC.
- g. Total Harmonic Distortion (THD) is the ratio of the RMS value of the input signal to the RMS sum of all harmonics.
- h. Spurious Free Dynamic Range (SFDR) is the ratio of the RMS full-scale range to the RMS value of the largest peak spurious component, including harmonics.

Analog Output Specifications

Table 5 lists the specifications for the analog output subsystem on the DT7816 module. Unless otherwise noted, specifications are typical at 25° C.

Table 5: Analog Output Subsystem Specifications

Feature	DT7816 Specifications
Number of analog output channels	2, differential
Resolution	16 bits
D/A type	LTC2752 Dual DAC
Output range	±10 V
Data encoding	Two's complement
Clocking	Enabled outputs updated simultaneously
Maximum sample frequency	400 kHz
Minimum sample frequency Internal clock: External clock:	1 Hz No minimum
Output FIFO	8 kSamples
Integral nonlinearity	0.4 LSB
Differential nonlinearity	0.2 LSB
Output impedance	0.5 Ω maximum
Output current	+10 mA
Settling time (0 to 10 V step to within 0.01% of final value)	2 μs, 0 V to ± full-scale
Short circuit output current	Limited to +40 mA maximum, continuous
Glitch impulse (mid-scale transition)	2.2 nV-seconds
Output noise, 0 V output	15 μVrms
Total Harmonic Distortion, THD ^a (-1 dBFS, 1 kHz sine wave, 400 kS/s)	0.01%, -80 dB
Offset after calibration	±100 μV
Offset error temperature coefficient	1 μV/° C
Gain error after calibration	±0.005% of reading
Gain error temperature coefficient	10 ppm/° C
ESD protection Arc: Contact:	8 kV 8 kV

a. THD measurements were made with a 16384 point FFT with a minimum 4-term Blackman Harris window.

Digital Input Specifications

Table 6 lists the specifications for the digital input signals available on the DT7816 module.

Table 6: Digital Input Specifications

Feature	Specifications
Number of general-purpose inputs	8
Input type	3.3 V HC, Schmitt trigger, 5 V tolerant
Input termination	22.1 k Ω pull-up resistor to 3.3 V
+ Voltage threshold	2.0 V typical
– Voltage threshold	0.8 V typical
Clocked with sample clock:	Yes, if the digital input port is included in the input data stream (bit 11)

Digital Output Specifications

Table 6 lists the specifications for the digital output signals available on the DT7816 module.

Table 7: Digital Output Specifications

Feature	Specifications
Number of general-purpose outputs	8
Output type	LVTTL
Logic high output voltage	2.4 V minimum
Logic low output voltage	0.4 V maximum
Logic high output current	-10 mA maximum
Logic low output current	4 mA maximum
Short circuit current	50 mA maximum
Clocked with sample clock	Yes, if the digital output lines are included in the output data stream (bits 24 to 31)

Tachometer Input Specifications

Table 8 lists the specifications for the tachometer input available on the DT7816 module.

Table 8: Tachometer Input Specifications

Feature	Specifications
Number of channels	1
Resolution	31 bits per channel
Input voltage range	± 30 V
Threshold voltage	+2 V with 0.5 V hysteresis
Input termination	None
Maximum input frequency	1 MHz ^a
Minimum pulse width high/low (minimum amount of time it takes a C/T to recognize an input pulse)	0.4 μ s
Clock frequency for tachometer measurements	12 MHz (83 ns resolution)
Overvoltage protection	± 30 V
Clocked with sample clock:	Yes, if the tachometer is included in the input data stream (bit 8)

a. Limited by signal integrity and input signal conditioning.

Measure Counter Specifications

Table 9 lists the specifications for the measure counter on the DT7816 module.

Table 9: Measure Counter Specifications

Feature	Specifications
Number of measure counters	1
Resolution	31 bits per channel
Clock frequency for measurement counters	48 MHz (20.8 ns resolution)
Maximum input frequency	10 MHz ^a
Minimum pulse width high/low	50 ns (0.4 μ s if the tachometer input is used for the starting edge and stopping edge)
Start and stop signals/edges	A/D conversion complete Tachometer input (falling or rising edge) Digital inputs 0 to 7 (falling or rising edge) C/T 0 Clock input (falling or rising edge) C/T 0 Gate input (falling or rising edge)
Clocked with sample clock:	Yes, if the measure counter is included in the input data stream (bit 10)

a. Limited by signal integrity and input signal conditioning.

General-Purpose Counter/Timer Specifications

Table 8 lists the specifications for the general-purpose counter/timer (C/T 0) on the DT7816 module.

Table 10: General-Purpose Counter/Timer Specifications

Feature	Specifications
Number of general-purpose counter/timers	1
Clock sources Internal: External:	48 MHz reference clock General-purpose inputs 0 to 7 on the Digital I/O header
Gate sources Internal: External:	Software General-purpose inputs 0 to 7 on the Digital I/O header
Counter/timer outputs	General-purpose outputs 0 to 7 on the Digital I/O header
Resolution	32 bits per channel
Clock divider Minimum: Maximum:	2 4,294,967,296
Clock output Minimum: Maximum:	0.0112 Hz 24 MHz
Maximum clock or gate input frequency	24 MHz ^a
Minimum pulse width (minimum amount of time it takes a C/T to recognize an input pulse)	50 ns
Input voltage range	0 to 3.3 V (+5 V tolerant)
Inputs Input logic load: High input voltage: Low input voltage: Low input current: Input termination:	1 LVTTTL 2.0 V minimum 0.8 V maximum –0.8 mA maximum 22 k Ω
Clocked with sample clock:	No

a. The integrity of the signal degrades at frequencies greater than 10 MHz.

Trigger Specifications

Table 11 lists the specifications for the triggers on the DT7816 module.

Table 11: Trigger Specifications

Feature	DT7816 Specifications
Trigger sources Internal software trigger: External digital trigger: Threshold trigger:	Software-initiated Software-selectable, general-purpose inputs 0 to 7 on the Digital I/O header Software-selectable, analog inputs 0 to 3
External trigger (digital) Trigger type: Input type: Input termination: + Voltage threshold: – Voltage threshold: Minimum pulse width high/low: Overvoltage protection:	Edge-sensitive, rising- or falling-edge trigger (software-selectable) 3.3 V high-speed CMOS, Schmitt trigger, 5 V tolerant 22.1 k Ω pull-up resistor to 3.3 V 2.0 V 0.8 V 250 ns ± 30 V
Threshold trigger Trigger type: Threshold level: Hysteresis:	Rising- or falling-edge threshold trigger on any analog input channel (software-selectable) –10 V to +10 V @ gain of 1; ± 1 V @ gain of 10 100 mV
Trigger delay	1 conversion period maximum

Master Oscillator Specifications

Table 12 lists the specifications for the master oscillator on the DT7816 module.

Table 12: Master Oscillator Specifications

Feature	Specifications
Frequency	48 MHz
Frequency stability	± 30 ppm ^a

- a. Stability budget consists of initial tolerance, operating temperature range, rated power supply voltage change, load change, 10-year aging, shock, and vibration.

Power, Physical, and Environmental Specifications

Table 13 lists the power, physical, and environmental specifications for the DT7816 module.

Table 13: Power, Physical, and Environmental Specifications

Feature	DT7816 Specifications
Power	+5 VDC \pm 5% from external supply ^a @ 1 A maximum
Warm-up time	10 minutes
Physical Dimensions Depth: Width: Height: Weight:	6.28 in (159.5 mm) 3.937 in (100 mm) 0.88 in (22.4 mm) 4 oz (113 g)
Environmental Operating temperature range: Storage temperature range: Relative humidity: Altitude:	0° C to 55° C –25° C to 85° C To 95%, noncondensing To 10,000 feet

- a. When using an external power source connected to screw terminal block TB1, the ramp-up time of the 5 V must be 50 ms or less to enable the power management input circuitry. It is recommended that you either apply the 5 V through a switch or use a light-duty power supply. High capacity supplies, such as bench supplies, may not meet the 50 ms ramp-up time.

Regulatory Specifications

The DT7816 module is CE-compliant. [Table 14](#) lists the regulatory specifications for the DT7816 module.

Table 14: Regulatory Specifications

Feature	DT7816 Specifications
Emissions (EMI)	FCC Part 15, Class A EN55011:2007 (Based on CISPR-11, 2003/A2, 2006)
Immunity	EN61326-1:2013 Electrical Equipment for Measurement, Control, and Laboratory Use <u>EMC Requirements</u> EN61000-4-2:2009 Electrostatic Discharge (ESD) 8 kV contact discharge, 8 kV air discharge, 4 kV horizontal and vertical coupling planes ^a EN61000-4-3:2006 Radiated electromagnetic fields, 3 V/m, 80 to 1000 MHz; 3 V/m, 1.4 GHz to 2 GHz; 1 V/m, 2 GHz to 2.7 GHz EN61000-4-4:2004 Electrical Fast Transient/Burst (EFT) 1 kV on data cables EN61000-4-6:2009 Conducted immunity requirements, 3 Vrms on data cables 150 kHz to 80 MHz
RoHS (EU Directive 2002/95/EG)	Compliant (as of July 1st, 2006)

a. An ESD event may require you to reboot the module.

Connector Specifications

Table 15 lists the connector specifications for the DT7816 module.

Table 15: Connector Specifications

Connector	Board Reference Designator ^a	Part Number of Connector on Module	Part Number of Mating Connector
Ethernet (RJ45) connector	J1	Bothhand LU1S041C-43 LF	–
USB host connector	J2	TE Connectivity 292336-1	–
USB device (client) connector	J4	TE Connectivity 292304-2	–
MicroSD connector	J5	Molex 503182-1853	–
External power supply Barrel connector:	J6, TB1	Jack on the module: Switchcraft #L722RA	Mating plug assembly, 0.08 in: Switchcraft #S761K
3-Pin header:		Phoenix Contact 1707434	Phoenix Contact 1839610
Analog I/O header	J16	3M 30320-6002HB	–
Digital I/O header	J15	3M 30334-6002HB	–
Digital Function header	J14	3M 30320-6002HB	–
Serial connectors ^b	J9, J10, and J11	FCI 68000-406HLF	–

a. The reference designator indicates the location of the connector on the board.

b. The optional EP405 USB to Serial TTL cable attaches to connector J10 and the USB port of your computer.

External Power Supply Specifications

Table 16 lists the specifications for the EP394 +5 V external power supply that is used with the DT7816 module.

Table 16: External Power Supply (EP394) Specifications

Feature	Specifications
Type	FRIWO medical power supply (GPP 10)
Input voltage	100 to 240 V AC ($\pm 10\%$)
Input current	250 mA
Frequency	50 to 60 Hz
Efficiency	80% typical at full load
Output voltage	5 V
Output current	1600 mA
Output ripple voltage	75 mVpp
Regulatory standards	UL, VDE, CE, Energy Star compliant

Table 17 lists the specifications for the external power supply that is used with the 3-position header on the DT7816 module.

Table 17: Specifications for the External Power Supply Used with the 3-Position Header on the DT7816 Module

Feature	Specifications
Output voltage	5 VDC to ± 0.25 V ^a
Output current	1 A
Noise and ripple	75 mVpp

- a. When using an external power source connected to screw terminal block TB1, the ramp-up time of the 5 V must be 50 ms or less to enable the power management input circuitry. It is recommended that you either apply the 5 V through a switch or use a light-duty power supply. High capacity supplies, such as bench supplies, may not meet the 50 ms ramp-up time.



Connector Pin Assignments and LEDs

Digital I/O Header (J15)	76
Analog I/O Header (J16).....	79
Digital Function Header (J14).....	80
USB Device (Client) Connector	81
USB Host Connector	82
Ethernet Connector	83
External +5 V Power Connector.....	84
Serial Connectors	86
STP781x Screw Terminal Panel.....	89
LED Status Indicators	92
User LEDs	94

Digital I/O Header (J15)

Figure 13 shows the layout of the 34-pin Digital I/O header (J15) on the DT7816 module. This header brings out the digital input and digital output signals on the module.

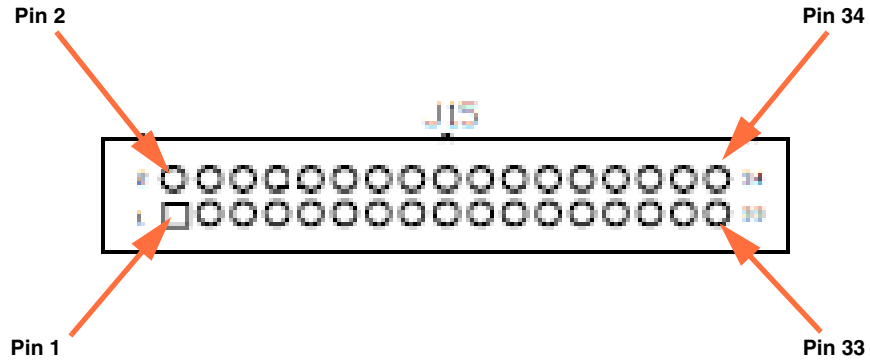

Figure 13: Layout of the Digital I/O Header (J15)

Table 18 lists the pin assignments for the Digital I/O header on the DT7816 module.

Table 18: Pin Assignments for the Digital I/O Header (J15)

Connector Pin Number	Signal Description	Connector Pin Number	Signal Description
1	General Purpose Input 0 ^a	2	Digital Ground
3	General Purpose Input 1 ^a	4	Digital Ground
5	General Purpose Input 2 ^a	6	Digital Ground
7	General Purpose Input 3 ^a	8	Digital Ground
9	General Purpose Input 4 ^a	10	Digital Ground
11	General Purpose Input 5 ^a	12	Digital Ground
13	General Purpose Input 6 ^a	14	Digital Ground
15	General Purpose Input 7 ^a	16	Digital Ground
17	General Purpose Output 0 ^b	18	Digital Ground
19	General Purpose Output 1 ^b	20	Digital Ground
21	General Purpose Output 2 ^b	22	Digital Ground
23	General Purpose Output 3 ^b	24	Digital Ground
25	General Purpose Output 4 ^b	26	Digital Ground
27	General Purpose Output 5 ^b	28	Digital Ground
29	General Purpose Output 6 ^b	30	Digital Ground
31	General Purpose Output 7 ^b	32	Digital Ground
33	+5 V (50 mA, maximum)	34	+5 V Return

- a. The input signals are buffered with a Schmitt trigger gate for noise immunity and are pulled up to 3.3 V with a 22.1 k Ω resistor. The input buffers are operated from 3.3 V and are 5 V logic tolerant. By default, these signals are configured as digital inputs.
- b. The output signals are driven by LVTTTL buffers and provide 4 mA sink and 10 mA source capabilities. By default, these signals are configured as digital outputs.

Using software, you can specify a general-purpose input signal as the signal source for the following destinations:

- Digital input (the default signal for each general-purpose input pin)
- External A/D trigger input
- External D/A trigger input
- External A/D clock input
- External D/A clock input
- Gate input for the general-purpose counter/timer (C/T 0)
- Clock input for the general-purpose counter/timer (C/T 0)

Using software, you can specify a general-purpose output signal as the signal source for one of these destinations:

- Digital output (the default signal for each general-purpose output pin)
- Clock output for the general-purpose counter/timer (C/T 0)

Note that a single general-purpose input may drive several destinations at the same time. However, a single general-purpose output can have only one driving source.

Analog I/O Header (J16)

Figure 14 shows the layout of the 20-pin Analog I/O header (J16) on the DT7816 module. This header brings out all the analog input and analog output signals on the module.

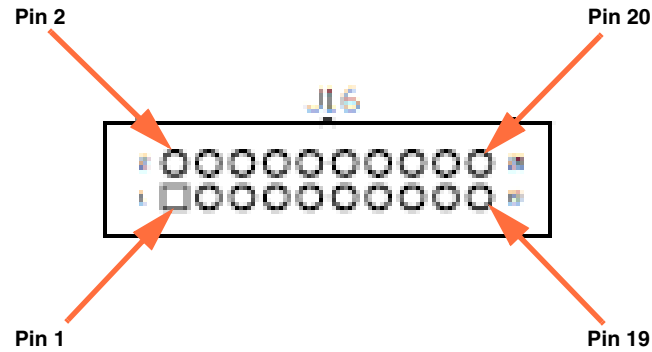

Figure 14: Layout of the Analog I/O Header (J16)

Table 19 lists the pin assignments for the Analog I/O header on the DT7816 module.

Table 19: Pin Assignments for the Analog I/O Header (J16)

Connector Pin Number	Signal Description	Connector Pin Number	Signal Description
1	Analog Output 0	2	Analog Output 0 Return
3	Analog Output 1	4	Analog Output 1 Return
5	Analog Input 0	6	Analog Ground
7	Analog Input 1	8	Analog Ground
9	Analog Input 2	10	Analog Ground
11	Analog Input 3	12	Analog Ground
13	Analog Input 4	14	Analog Ground
15	Analog Input 5	16	Analog Ground
17	Analog Input 6	18	Analog Ground
19	Analog Input 7	20	Analog Ground

Digital Function Header (J14)

Figure 15 shows the layout of the 20-pin Digital Function header (J14) on the DT7816 module. This header brings out the tachometer input signal on the module.

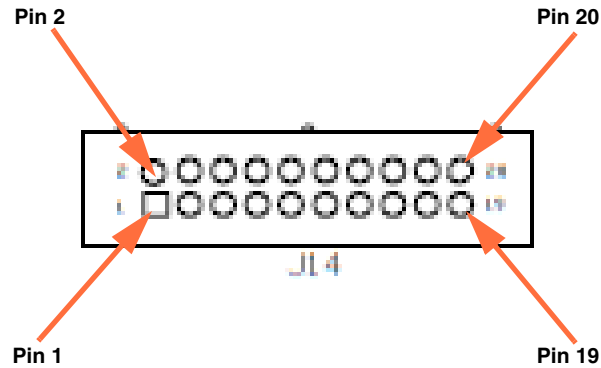

Figure 15: Layout of the Digital Function Header (J14)

Table 20 lists the pin assignments for the Digital Function header on the DT7816 module.

Table 20: Pin Assignments for the Digital Function Header (J14)

Connector Pin Number	Signal Description	Connector Pin Number	Signal Description
1	Tachometer Input	2	Digital Ground
3	Reserved	4	Digital Ground
5	Digital Ground	6	Digital Ground
7	Digital Ground	8	Digital Ground
9	Digital Ground	10	Digital Ground
11	Digital Ground	12	Digital Ground
13	Digital Ground	14	Digital Ground
15	Digital Ground	16	Digital Ground
17	Digital Ground	18	Digital Ground
19	Digital Ground	20	Digital Ground

USB Device (Client) Connector

Figure 16 shows the layout of the USB device (client) connector (J4) on the ARM block (bottom board) of the DT7816 module. This is a type B connector.

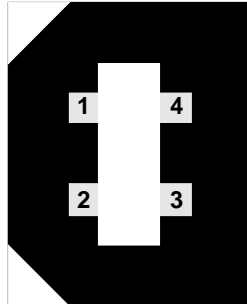

Figure 16: Layout of the USB Type B Connector for the USB Device (Client) Port

Table 21 lists the pin assignments for the USB type B connector on the DT7816 module for the USB device (client) port.

Table 21: Pin Assignments for the USB Type B Connector for the USB Device (Client) Port

Connector Pin Number	Signal Description	Connector Pin Number	Signal Description
1	USB +5 V	3	USB Data +
2	USB Data –	4	USB Ground

Note: The outer shell provides cable shield to chassis ground.

USB Host Connector

Figure 16 shows the layout of the USB host connector (J2) on the ARM block (bottom board) of the DT7816 module. This is a type A connector.

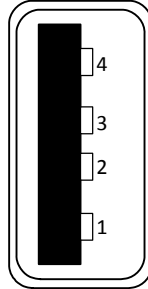

Figure 17: Layout of the USB Type A Connector for the USB Host Port

Table 22 lists the pin assignments for the USB type A connector on the DT7816 module for the USB host port.

Table 22: Pin Assignments for the USB Type B Connector for the USB Device (Client) Port

Connector Pin Number	Signal Description
1	USB +5 V
2	USB Data –
3	USB Data +
4	USB Ground

Note: The outer shell provides cable shield to chassis ground.

Ethernet Connector

Figure 16 shows the layout of the Ethernet (RJ45) connector (J1) on the ARM block (bottom board) of the DT7816 module.

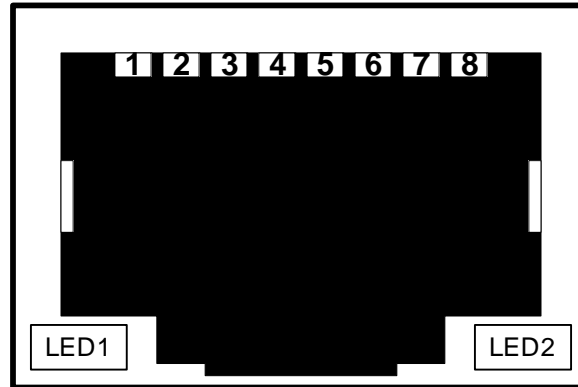

Figure 18: Layout of the Ethernet Connector

Table 23 lists the pin assignments for the Ethernet connector on the DT7816 module.

Table 23: Pin Assignments for the Ethernet Connector

Connector Pin Number	Signal Description	Connector Pin Number	Signal Description
1	Transmit+	5	Reserved
2	Transmit-	6	Receive-
3	Receive+	7	Reserved
4	Reserved	8	Reserved
LED1	Activity (green)	LED2	Link (yellow)

Note: The outer shell provides cable shield to chassis ground.

External +5 V Power Connector

The DT7816 module provides two connectors for attaching a +5 VDC external power supply: a barrel connector (J6) and a 3-position Phoenix header.

Figure 19 shows the layout and signal descriptions of the barrel connector (J6).

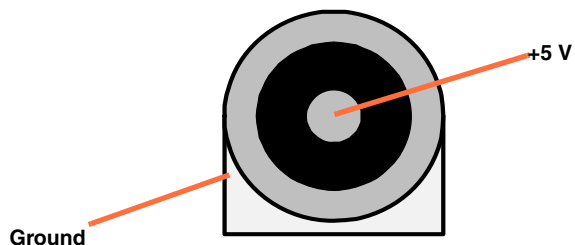

Figure 19: Layout of the +5 V Power Barrel Connector (J6)

You can connect the optional EP394 +5 VDC external power supply to the barrel connector, if desired. Refer to [page 73](#) for detailed specifications of the EP394 power supply.

Figure 20 shows the layout of the 3-pin Phoenix header (TB1) on the DT7816 module.

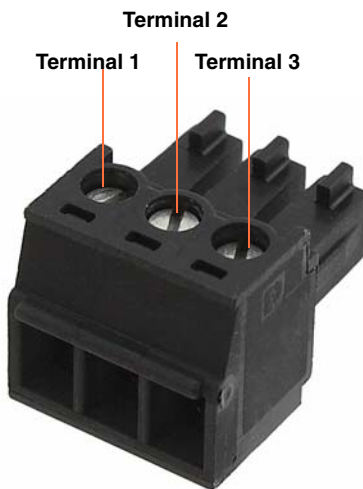

Figure 20: Layout of the 3-Position Phoenix Header

[Table 24](#) lists the terminal assignments for the 3-position header on the DT7816 module.

Table 24: Terminal Assignments for the 3-Position Header (TB1) on the DT7816 Module

Terminal Number	Signal Description
1	+5 VDC
2	Digital Ground
3	Chassis Ground

Note that you must connect an external power supply to this header that meets the specifications described on [page 73](#).

Serial Connectors

Figure 16 shows the layout of the 6-pin serial connectors (J9, J10, and J11) on the DT7816 module.

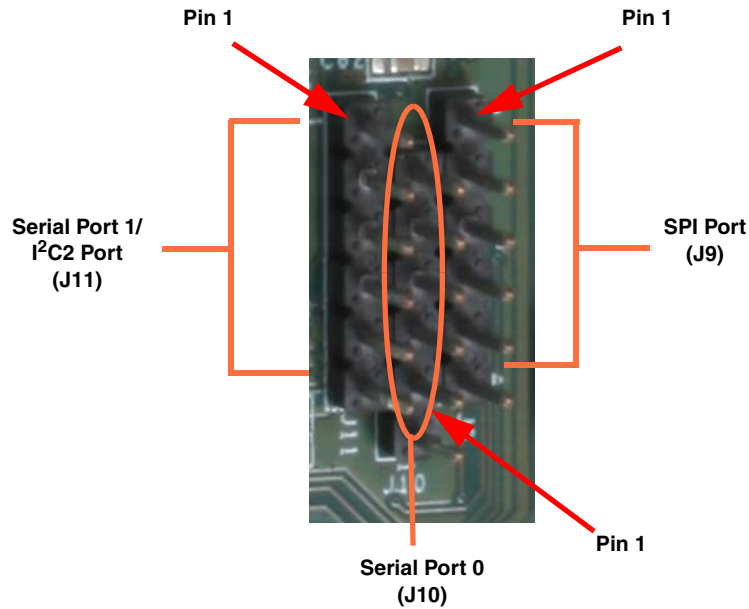
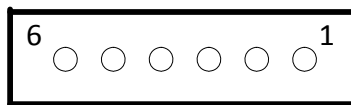

Figure 21: Layout of the Serial Connectors

These connectors are described in the sections that follow.

Serial Port 0 (UART 0)

Figure 16 shows the layout of the Serial port 0 (J10) on the DT7816 module.



***Note that the pin order of connector J10 is reversed from connectors J9 and J11.**

Figure 22: Layout of Serial Port 0 (J10)

Table 25 lists the pin assignments for serial port 0 on the DT7816 module.

Table 25: Pin Assignments for Serial Port 0 (J10) on the DT7816 Module

Connector Pin Number	Signal Description
1	DGND
2	Not Connected
3	Not Connected
4	UART0_RX
5	UART0_TX
6	Not Connected

SPI Connector

Figure 16 shows the layout of the SPI connector (J9) on the DT7816 module.

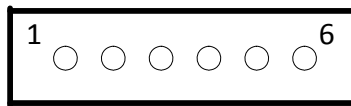

Figure 23: Layout of SPI Connector (J9)

Table 26 lists the pin assignments for the SPI connector on the DT7816 module.

Table 26: Pin Assignments for SPI Connector (J9) on the DT7816 Module

Pin Number	Signal Description
1	SPI1_D0
2	SPI1_SCLK
3	SPI1_CS0
4	SPI1_D1
5	DGND
6	+3.3 V

Serial Port 1 / I²C2 Connector

Figure 16 shows the layout of the Serial port 1 / I²C2 connector (J11) on the DT7816 module.

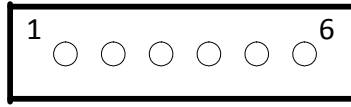

Figure 24: Layout of Serial Port 1 / I²C Port (J11)

Table 27 lists the pin assignments for the Serial port 1 / I²C connector on the DT7816 module.

Table 27: Pin Assignments for Serial Port 1 / I²C Connector (J11) on the DT7816 Module

Pin Number	Signal Description
1	UART1_RX
2	UART1_TX
3	I ² C2_SDA
4	I ² C2_SCL
5	DGND
6	+3.3 V

STP781x Screw Terminal Panel

The STP781x screw terminal panel contains one 20-pin connector that mates to the Analog I/O header on the DT7816 module, one 34-pin connector that mates to the Digital I/O header on the DT7816 module, one 20-pin connector that mates to the Digital Function header, and screw terminal blocks for wiring the I/O signals.

Figure 25 shows the layout of the STP781x screw terminal panel.

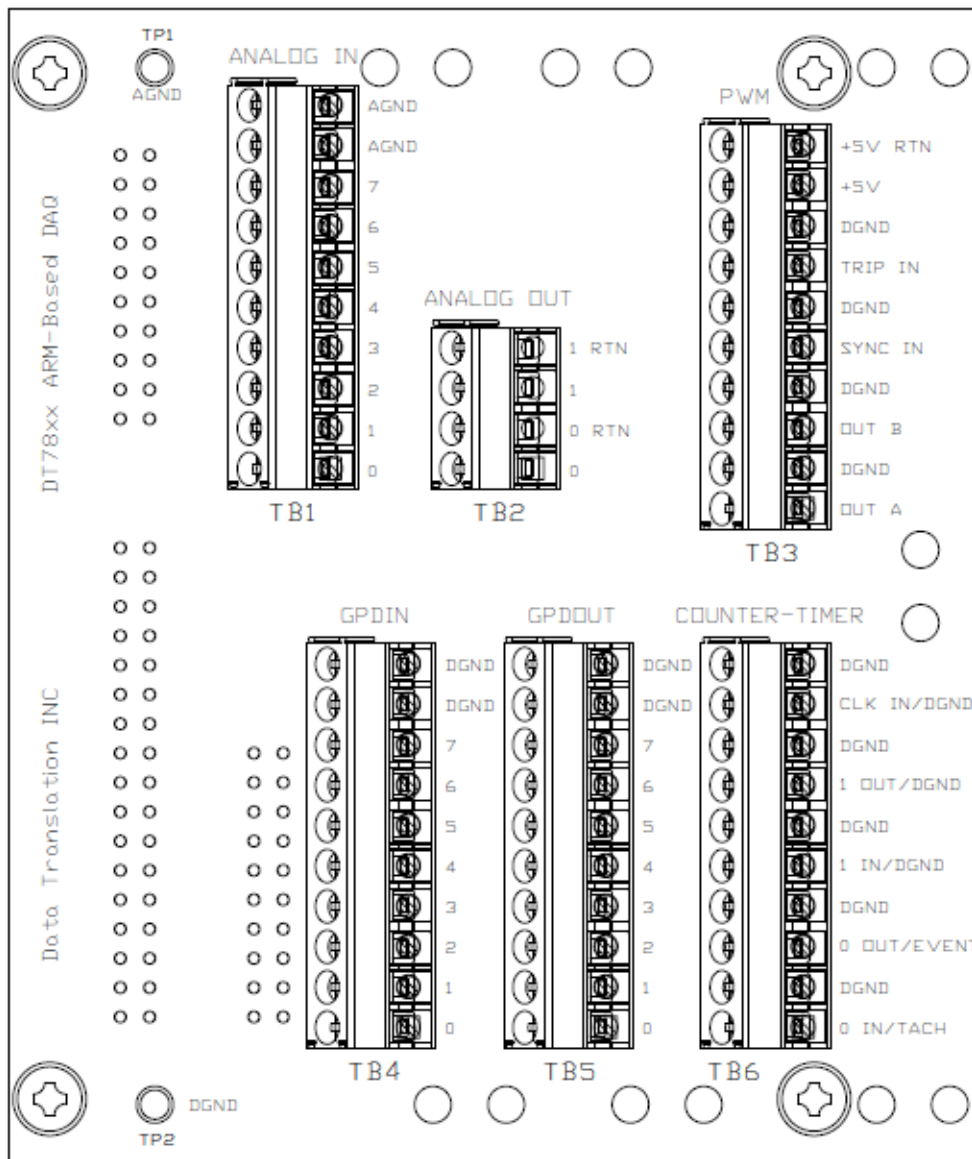

Figure 25: Layout of the STP781x Screw Terminal Panel

Table 28 lists the screw terminal assignments for the STP781x screw terminal panel.

Table 28: Screw Terminal Assignments for the STP781x Screw Terminal Panel

Screw Terminal Block Number	Screw Terminal Name	Signal Descriptions for the DT7816
TB1 - ANALOG INPUT	AGND	Analog Ground
	AGND	Analog Ground
	7	Analog Input 7
	6	Analog Input 6
	5	Analog Input 5
	4	Analog Input 4
	3	Analog Input 3
	2	Analog Input 2
	1	Analog Input 1
	0	Analog Input 0
TB2 - ANALOG OUTPUT	1 RTN	Analog Output 1 Return
	1	Analog Output 1
	0 RTN	Analog Output 0 Return
	0	Analog Output 0
TB3 - PWM ^a	+5 V RTN	+5 V Output Return
	+5 V	+5 V Output (50 mA, maximum)
	DGND	Digital Ground
	TRIP IN	Digital Ground
	DGND	Digital Ground
	SYNC IN	Digital Ground
	DGND	Digital Ground
	OUT B	Digital Ground
	DGND	Digital Ground
	OUT A	Digital Ground
TB4 - GP DIN	DGND	Digital Ground
	7	General-Purpose Input 7 ^b
	6	General-Purpose Input 6 ^b
	5	General-Purpose Input 5 ^b
	4	General-Purpose Input 4 ^b
	3	General-Purpose Input 3 ^b

Table 28: Screw Terminal Assignments for the STP781x Screw Terminal Panel (cont.)

Screw Terminal Block Number	Screw Terminal Name	Signal Descriptions for the DT7816
TB4 - GP DIN (cont.)	2	General-Purpose Input 2 ^b
	1	General-Purpose Input 1 ^b
	0	General-Purpose Input 0 ^b
TB5 - GP DOUT	DGND	Digital Ground
	DGND	Digital Ground
	7	General-Purpose Output 7 ^b
	6	General-Purpose Output 6 ^b
	5	General-Purpose Output 5 ^b
	4	General-Purpose Output 4 ^b
	3	General-Purpose Output 3 ^b
	2	General-Purpose Output 2 ^b
	1	General-Purpose Output 1 ^b
0	General-Purpose Output 0 ^b	
TB6 - COUNTER TIMER ^c	DGND	Digital Ground
	CLK IN / DGND	Digital Ground
	DGND	Digital Ground
	1 OUT / DGND	Digital Ground
	DGND	Digital Ground
	1 IN / DGND	Digital Ground
	DGND	Digital Ground
	0 OUT / EVENT	Reserved
	DGND	Digital Ground
	0 IN / TACH	Tachometer Input

- a. The DT7816 does not support PWM signals; therefore, screw terminal block TB3 is not used on the STP781x screw terminal panel when used it is with the DT7816 module.
- b. By default, general-purpose inputs 0 to 7 are configured as digital input signals and general-purpose outputs 0 to 7 are configured as digital output signals.
- c. For the DT7816, the only signals accessible through screw terminal block TB6 are the tachometer input and the digital ground signals.

LED Status Indicators

The DT7816 module has a Power LED and trigger LED indicators, as shown in [Figure 26](#).

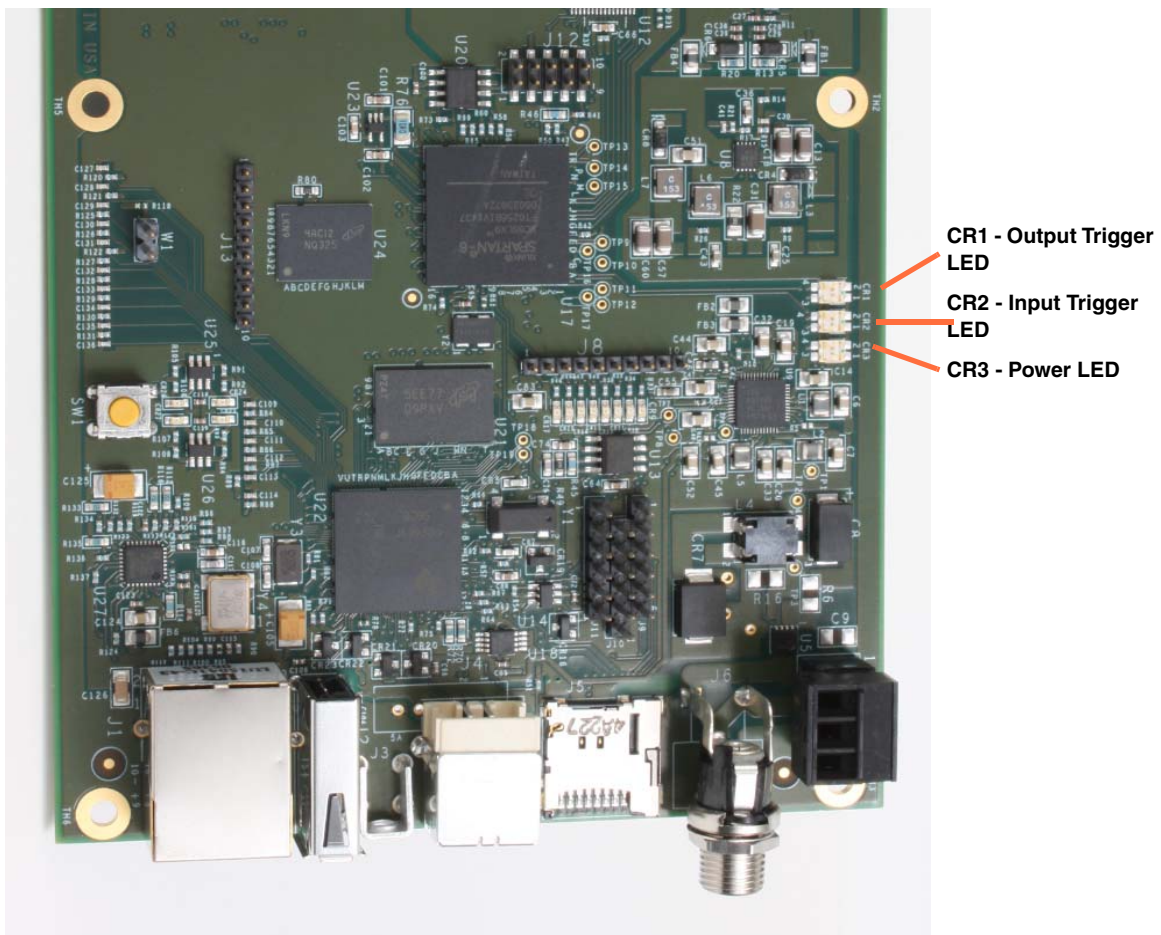

Figure 26: Trigger and Power LEDs on the DT7816 Module

The status LEDs are described in [Table 29](#).

Table 29: LED Status Indicators on the DT7816 Module

LED	Color of the LED	Status Description
CR1 - Output Trigger LED	Off	Idle.
	Solid amber	Output subsystem armed; it is waiting for an external digital trigger or threshold trigger (the module must have been configured for one of these trigger types).
	Solid green	Output subsystem has been triggered.

Table 29: LED Status Indicators on the DT7816 Module (cont.)

LED	Color of the LED	Status Description
CR2 - Input Trigger LED	Off	Idle.
	Solid amber	Input subsystem armed; it is waiting for an external digital trigger or threshold trigger (the module must have been configured for one of these trigger types).
	Solid green	Input subsystem has been triggered.
CR3 - Power LED	Off	Power off.
	Solid green	Power on.
	Blinking amber	Module is active and converting data on one or more channels.

User LEDs

The DT7816 has eight user LEDs, shown in [Figure 27](#). Header J8, also shown in [Figure 27](#), provides debug pins that correspond to the user LEDs. The value of a debug pin reflects the state of the corresponding user LED, where the pin has a value of 0 if the LED is off or a value of 1 if the LED is on.

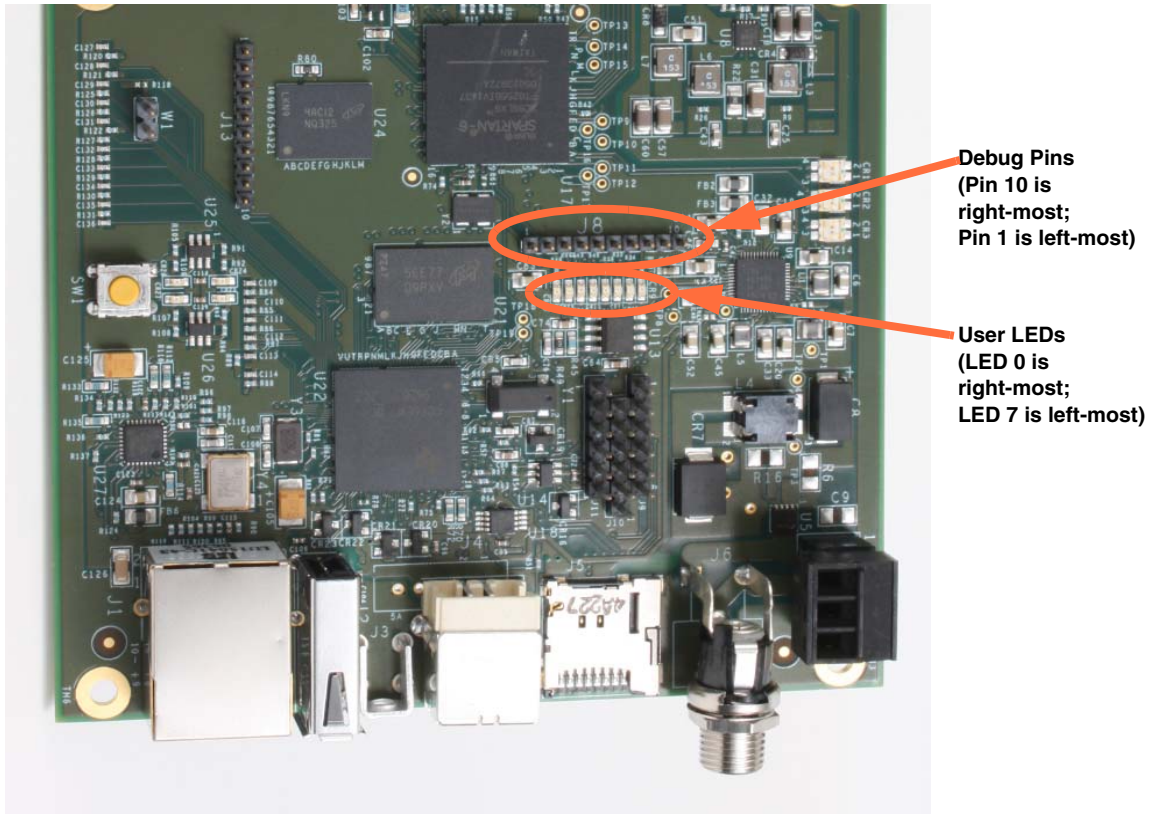

Figure 27: User LEDs and Debug Pins on the DT7816 Module

[Table 30](#) lists the pin descriptions of header J8 on the DT7816.

Table 30: Debug Pins of Header J8

Pin	Pin Description
1	Debug_D7; corresponds to user LED 7.
2	Debug_D6; corresponds to user LED 6.
3	Debug_D5; corresponds to user LED 5.
4	Debug_D4; corresponds to user LED 4.
5	Debug_D3; corresponds to user LED 3.
6	Debug_D2; corresponds to user LED 2.
7	Debug_D1; corresponds to user LED 1.
8	Debug_D0; corresponds to user LED 0.
9	Digital Ground
10	Digital Ground

Using file I/O commands, you can turn the user LEDs either on or off. Refer to the *DT7816 File I/O Programming Manual* for more information.

Symbols

+5 V power connector [84](#)

Numerics

3-position Phoenix header [84](#)

A

accessories

EP405 USB to serial TTL debug cable [18](#)

STP781x screw terminal panel [18](#)

aliasing [28](#)

AM3352 processor [23](#)

Analog I/O header (J16) [79](#)

analog input

calibrating [55](#)

channels [25](#)

data format [28](#)

error conditions [29](#)

gain [25](#)

input range [25](#)

resolution [25](#)

sample clock [28](#)

specifications [60](#)

triggers [27](#)

analog output

calibrating [56](#)

channels [30](#)

clock sources [30](#)

continuous operations [31](#)

conversion modes [31](#)

data format [32](#)

error conditions [32](#)

gain [30](#)

ranges [30](#)

resolution [30](#)

single-value operations [31](#)

specifications [62](#)

ARM block [23](#)

ARM processor [23](#)

C

C/T, *see* counter/timer [66](#), [67](#)

calibrating the module

analog input subsystem [55](#)

analog output subsystem [56](#)

channels

analog input [25](#)

analog output [30](#)

counter/timer [35](#)

digital I/O [46](#)

digital input [47](#)

digital output [47](#)

measure counter [42](#)

tachometer [33](#)

client port, USB [24](#)

clock sources

analog input [28](#)

analog output [30](#)

counter/timer [36](#)

connectors

+5 V power [84](#)

Ethernet [83](#)

I2C [88](#)

serial [86](#)

serial port 0 [86](#)

serial port 1 [88](#)

SPI [87](#)

USB client [81](#)

USB host [82](#)

conversion modes

continuous analog output [31](#)

single-value analog output [31](#)

conversion rate [26](#)

counter/timer

channels [35](#)

clock sources [36](#)

gate types [36](#)

specifications [67](#)

subsystem specifications [66](#)

counting events [38](#)

customer service [51](#)

D

data format

analog input [28](#)

analog output [32](#)

DDR3 memory [23](#)

debug pins of header J8 [94](#)

- Digital Function header (J14) 80
- Digital I/O header (J15) 76
- digital I/O operations
 - continuous digital input 47
 - continuous digital output 47
 - lines 46
 - synchronous read 46
 - synchronous write 46
- digital trigger 27, 32
- DIN power connector 84
- duty cycle 37

E

- EEPROM 23
- embedded NAND flash 23
- environmental specifications 70
- EP394 power supply 73
- EP405 USB to serial TTL debug cable 18
- errors
 - analog input 29
 - analog output 32
- Ethernet connector 83
- event counting 38
- external clock 36
- external digital trigger 27, 32

F

- factory service 51
- FIFO
 - input 28
 - output 32
- file I/O commands 17
- flash 23
- formatting data
 - analog input 28
 - analog output 32
- FPGA 24
- frequency
 - analog input operations 28, 30
 - external C/T clock 36

G

- gain 25, 30
- gate type 36
- generating one-shot pulses 40
- generating pulses 39
- GMPC bus interface 24

H

- header
 - Analog I/O (J16) 79
 - Digital Function (J14) 80
 - Digital I/O (J15) 76
- header J8 94
- host port, USB 24

I

- I2C2 connector 24, 88
- idle mode 41
- input
 - channels 25
 - ranges 25
 - resolution 25
- input FIFO 28
- Input Trigger LED 93
- internal C/T clock 36
- internal sample clock 28

J

- J14 header 80
- J15 header 76
- J16 header 79
- J8 header 94

L

- LEDs
 - Input Trigger 92, 93
 - Output Trigger 92
 - Power 92, 93
 - user 94
- lines, digital I/O 46

M

- master oscillator 28
 - specifications 69
- measure counter
 - features 42
 - specifications 66
- memory 23
- micro SD card 23

N

- NAND flash 23
- non-retriggerable one-shot 40

Nyquist Theorem 28

O

oscillator, specifications 69

output

clock sources 30

ranges 30

output FIFO 32

output pulses 39, 40

Output Trigger LED 92

P

physical specifications 70

polarity of counter output signal 37

ports, digital I/O 46

power connector

3-pin Phoenix header 84

DIN 84

Power LED 93

power specifications 70, 73

processor 23

pulse output

non-retriggerable one-shot 40

period 37

pulse width 37

rate generation 39

pulse width 37

R

ranges

analog input 25

analog output 30

rate generation 39

regulatory specifications 71

resolution

analog input 25

analog output 30

digital I/O 46

returning boards to the factory 51

RMA 51

S

sample clock 28

SD card 23

SDRAM 23

serial connectors 86

serial peripheral interface 24, 87

serial port 0 24, 86, 87, 88

serial port 1 24

serial port 1 connector 88

single-value analog output 31

size, module 70

software trigger 27, 32

specifications 59

analog input 60

analog output 62

connector 72

counter/timer 67

counter/timer specifications 66

environmental 70

external power for the 3-position header 73

external power supply 73

master oscillator 69

physical 70

power 70

regulatory 71

tachometer input 65

triggers 68

SPI connector 87

SPI port 24

start trigger

external digital (TTL) trigger 27, 32

software 27, 32

threshold trigger 27

STP781x screw terminal panel 18, 89

T

tachometer input

features 33

specifications 65

technical support 50

threshold trigger 27

triggers

external 27, 32

software 27, 32

specifications 68

threshold 27

troubleshooting 50

TTL trigger 27, 32

type A connector 82

type B USB connector 81

U

UART 0 24, 86, 87, 88

UART 1 24, 88

units, counter/timer 35

USB client port [24](#)
USB device connector [81](#)
USB device port [24](#)
USB host connector [82](#)
USB host port [24](#)
user LEDs [94](#)

V

voltage ranges [25](#)