



DL-110-E



DL-110-E-W



DL-120-E



DL-120-E-W

Features

- Illumination Measurement Range: 0 to 100,000 Lux
- Temperature Measurement Range: -20 to +60°C
- Humidity Measurement Range: 0 to 100% RH
- Able to store up to 600,000 records with date and time stamps
Free Software Utility, iOS APP and Android App Included
- Supports the DCON, Modbus RTU, Modbus TCP and MQTT Protocols
- Includes RS-485/Ethernet Communication Interfaces
- Includes redundant power inputs: PoE (IEEE 802.3af, Class 1) and DC input
- Supports Web Configuration and Firmware Update via Ethernet
- IP67 Protection Approval
- DIN-Rail or Wall Mounting



Introduction

The DL-110-E / DL-120-E are Data Logger devices that can be used to record illumination, temperature, humidity and dew point data, together with date and time stamp information. Up to 600,000 downloadable records can be stored. Real-time data can be accessed from the DL-110-E / DL-120-E device from anywhere and at any time using the free Windows software, the iOS App or the Android App, as long as they are connected to the same local network as the Data Logger. The DL-110-E / DL-120-E supports popular industrial protocols such as DCON, Modbus RTU, Modbus TCP, as well as the emerging machine-to-machine (M2M)/IoT (Internet of Things) connectivity protocol – MQTT. The DL-110-E / DL-120-E Data Logger can be connected using a variety of communication interfaces, including Ethernet and RS-485, meaning that the device can be easily integrated into existing HMI or SCADA systems, and are easy to maintain in a distributed control system.

Support the MQTT protocol for IoT Applications

The MQTT protocol is designed for the efficient exchange of real-time data between a sensor and a mobile device. It operates via TCP/IP and is in widest use today in "machine-to-machine" (M2M) and "Internet of Things" applications.

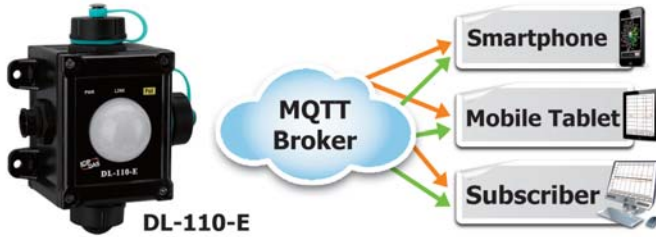

Built-in Web Server

The built-in web server provides the ability to easily log in to the DL-110-E / DL-120-E module via a standard web browser, allowing users to monitor the data and configure the settings without the need to install any software on the terminal.

Get Real-time Data Anywhere and Anytime

The iAir App is a free and easy to install application for iOS or Android Phones or Tablets, and can be used to obtain real-time data from DL-110-E / DL-120-E modules over a Wi-Fi network anytime and anywhere. The iAir App can access a DL-110-E / DL-120-E module either by specifying a specific IP address or by searching for all modules connected to the same Ethernet segment.



Free and Powerful DL300 Utility

The DL-300 Utility can be used to configure a module and monitor real-time data, as well as display the run chart, log alarm events, or group DL-110-E / DL-120-E modules so that the status of distribution groups can be viewed and managed. The utility also allows the log data to be downloaded and exported to a .CSV file that can then be imported into any industry-standard software or spreadsheet for analysis.

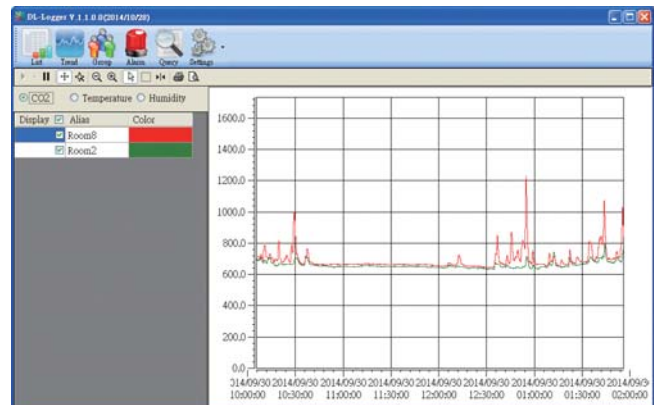

Specifications

Model	DL-110-E	DL-110-E-W	DL-120-E	DL-120-E-W
Illuminance Measurement				
Range	0 to 100,000 Lux			
Resolution	1 Lux			
Accuracy	±5%			
Temperature Measurement				
Range	-20 to +60°C (-31 to +176°F)		-	
Resolution	0.1°C		-	
Accuracy	Typical: ±0.4°C; refer to figure 2		-	
Relative Humidity Measurement				
Range	0 to 100% RH		-	
Resolution	0.1% RH		-	
Accuracy	Typical: ±3% RH @ 20 ~ 80% RH; refer to figure 1		-	
LED Indicators				
PWR	System indicator (Green)			
Link	Link/Act indicator (Green)			
PoE	PoE indicator (Red)			
Software				
Built-in Web Server	Yes			
Communication				
Ethernet Port	10/100 Base-TX, 8-Pin RJ-45 x1 (Auto-negotiating,			
Security	IP filter (whitelist) and Password (web)			
Protocol	Modbus TCP and MQTT(Ethernet)			
Dual Watchdog	Yes, Module (2.3 seconds), Communication			
System				
Real Time Clock	Yes			
Data Logger	Yes, 600,000 Records			
Electrical				
Powered via Terminal Block	+12 to +48 VDC			
Powered via PoE	IEEE 802.3af, Class 1 (require a PoE switch or injector)			
Power Consumption	PoE	1.2 W (Max.)		
	Non-PoE	1.1 W (Max.)		
Mechanical				
Dimensions (W x L x H)	100 mm x 131 mm x 67 mm		100 mm x 112 mm x 67 mm	
Waterproof Level	IP67			
Installation	DIN-Rail or Wall mounted			
Module Housing	Black Cover	White Cover	Black Cover	White Cover
Environment				
Operating Temperature	-20 to +60°C			
Storage Temperature	-30 to +80°C			
Humidity	10 to 95% RH, Non-condensing			

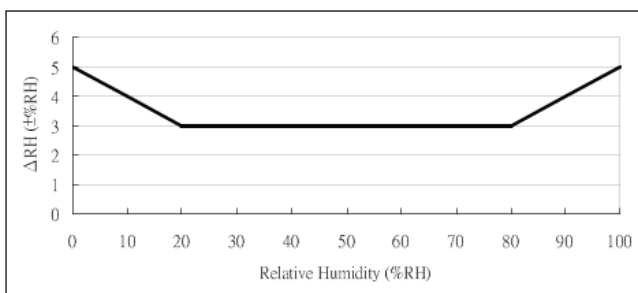

Figure 1: Maximum RH-tolerance at 25°C per sensor

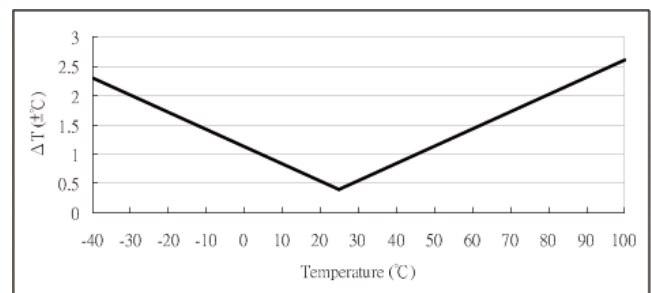
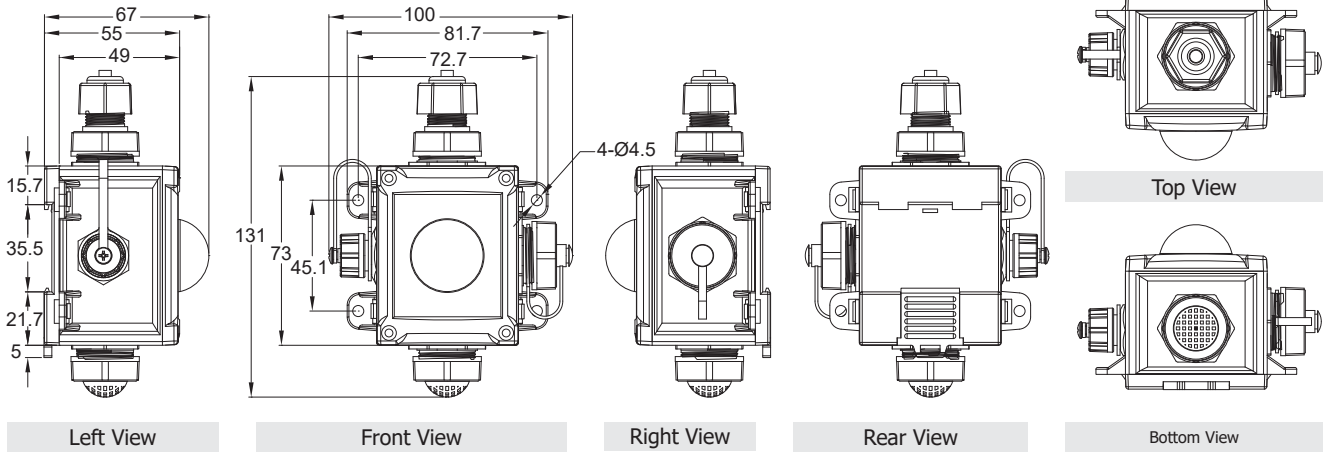

Figure 2: Maximum T-tolerance per sensor

■ Dimensions (Units: mm)

DL-110-E/DL-110-E-W



DL-120-E/DL-120-E-W

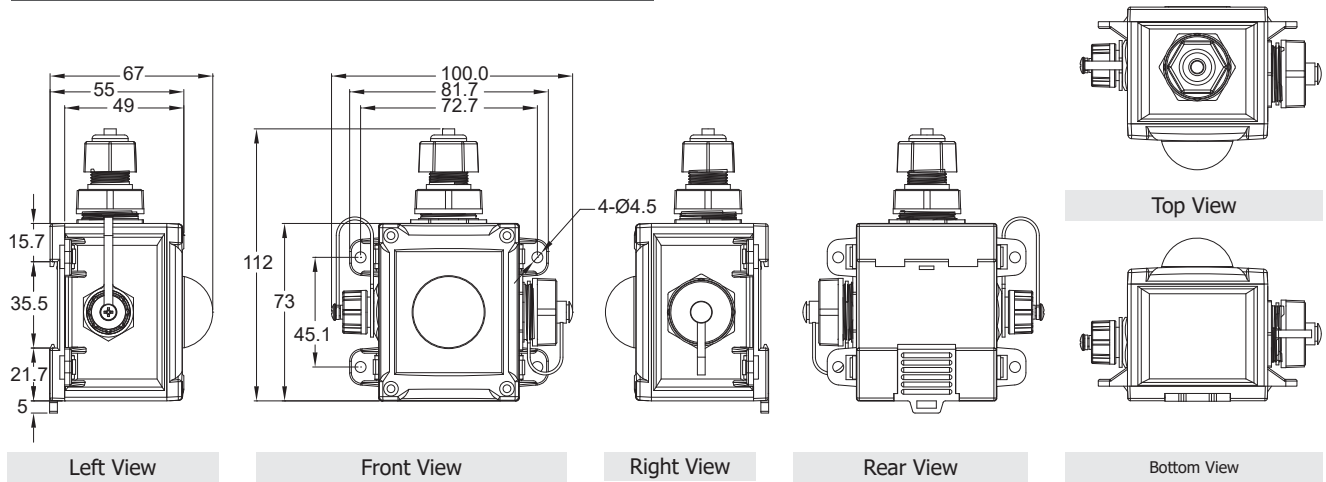

■ Appearance

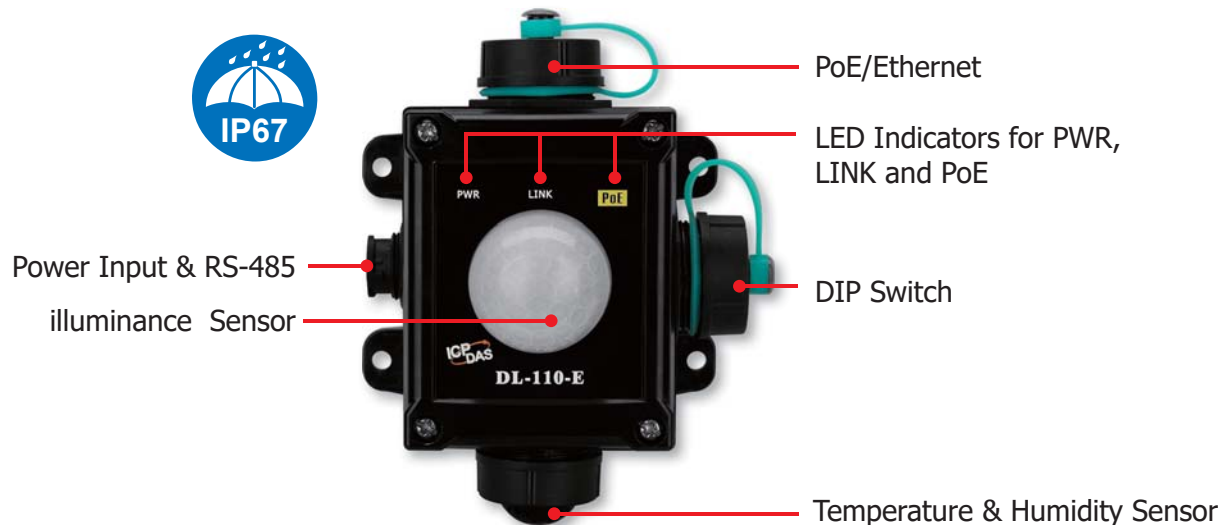

Applications

Greenhouse Automation Cloud Management Solution

The greenhouse automation system can use the DL series to provide environmental monitoring such as illuminance (DL-110-E / DL-120-E), temperature and humidity (DL-300/DL-100 series), etc., to make plants grow well, increase crop yield, improve quality, provide product traceability record, and control of sunshine and sprinkler systems. Install WISE-523xM-4GE IIoT smart host with iCAM series network camera can carry out greenhouse monitoring and management, provide further personnel access and thief intrusion monitoring. When finds someone intrusion, it will automatically send SMS, LINE/WeChat to the owner, security and related personnel, to quickly protect property and safety. WISE supports cloud management software IoTstar, so owners can easily build cloud management system solutions and keep with the latest situation in the greenhouse.

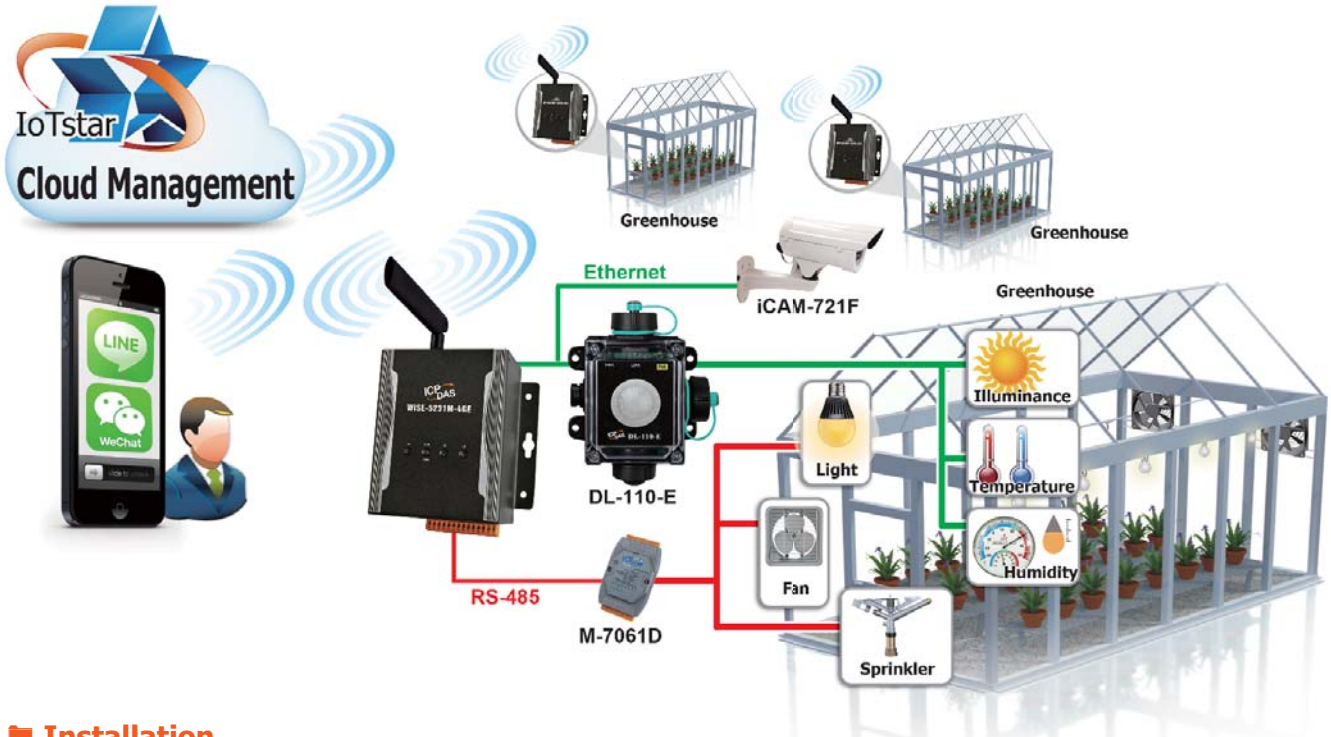

Installation

DIN-Rail







Wall mounted



Ordering Information

DL-110-E CR	Remote Illuminance/Temperature/Humidity/Dew Point Data Logger Module with Ethernet/RS-485 Inter face and PoE (Black Cover) (RoHS)
DL-110-E-W CR	DL-110-E with White Cover (RoHS)
DL-120-E CR	Remote Illuminance Data Logger Module with Ethernet/RS-485 Inter face and PoE (Black Cover) (RoHS)
DL-120-E-W CR	DL-120-E with White Cover (RoHS)

Accessories

Model	NS-205-IP67	NS-205PSE-IP67	NS-208PSE-IP67	NS-208-IP67
				
PoE	–	802.3af x 4	802.3af x 8	–
Input Voltage Range	+10 VDC ~ +30 VDC (1 kV Isolated)	+46 VDC ~ +53 VDC		+12 VDC ~ +53 VDC
Installation	Wall Mounted	Wall Mounted	Wall Mounted	
Dimensions (W x L x H) (Units: mm)	85 x 76 x 137	85 x 76 x 137	190 x 155 x 104	

MDR-60-48	48 V/1.25 A, 60 W Power Supply with DIN-Rail Mounting
DIN-KA52F-48	48 V/0.52 A, 25 W Power Supply with DIN-Rail Mounting
DR-120-48	48 V/2.5 A, 120 W Power Supply with DIN-Rail Mounting

<p>IP67 RJ-45 Plug</p>  <p>4SASO-0001</p>	<p>Cap with Tether</p>  <p>4SASO-0004</p>	<p>IP67 Power Plug</p>  <p>4SIOIK0000013</p>
--	--	---